

Serie amba

Características técnicas

SUPERFICIE: Tablero laminado de 25mm.

ESTRUCTURA: Basada en laterales de tablero laminado de 25mm

PIES: Protección antihumedad de poliestireno.

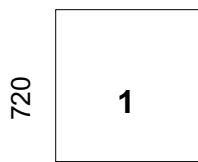

1

900

1-Pata Mesa ancho 1200

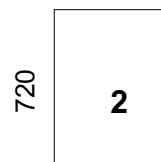

2

680

2-Pata Mesa ancho 800

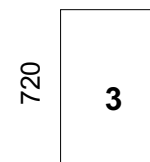

3

552

3-Pata Mesa ancho 600

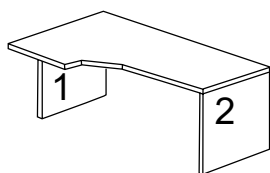

mesa compacta

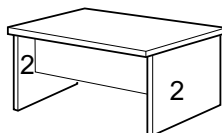

mesa 800

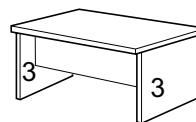

mesa 600

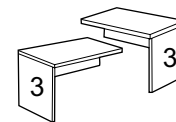

ala

Acabados

Laminado

Recubrimiento laminado sobre tablero de 25mm. de grosor. Cantos de ABS de 2mm. de espesor, aplicado con cola termofusible y redondeado.



blanco roto (68) roble (60) peral (54) wengue (66) gris (61) haya (52)

Desviaciones de color lógicas del proceso de impresión.

Estructura

sólo estructura



aluminio (67)

Programa

Mesas rectas de 800mm.

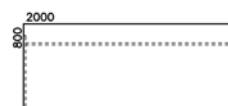
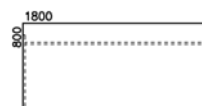
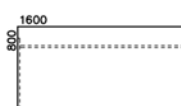
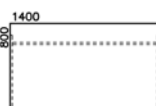
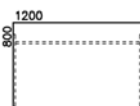
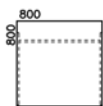

Mesas rectas de 600mm.

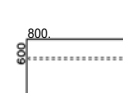
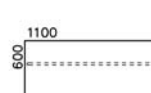
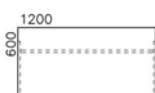
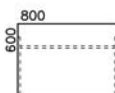

Ala de 600 .

Mesas compactas MAD/MAI.

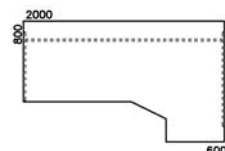
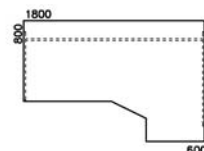
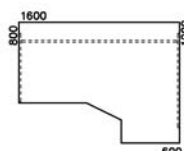
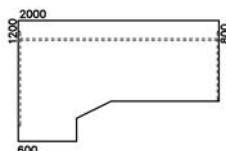
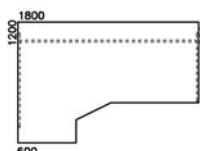
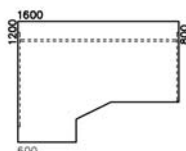

Serie amba

Código de producto.

El código final del pedido vendrá determinado por los cinco dígitos que vienen en las tablas inferiores, más los correspondientes.

al acabado de la estructura que aparecen en la tabla de la derecha.

Ejemplo:

Mesa 80 x80 blanca : **B 200 68** -- estructura todo su color : **B 200 68 68**

Mesa 80 x180 roble : **B 208 60** -- estructura aluminio : **B 208 60 67**

ACABADOS ESTRUCTURA

aluminio (67) todo su color



K -----67

Mesa recta 800mm. grosor 25mm.

| Modelo | | | | | | | P.V.P | Packing | |
|--------------|------------------|------------|------------|-------------|-----------|-----------|-----------------|--|--|
| | blanco roto (68) | roble (60) | peral (54) | wengue (66) | gris (61) | haya(52) | | | |
| | | | | | | | | | |
| B 200 | B 20068-- | B 20060-- | B 20054-- | B 20066-- | B 20061-- | B 20052-- | 91,49 € | 29,79 kg Vol. 0,048 m ³ Nº bultos:3 | |
| B 202 | B 20268-- | B 20260-- | B 20254-- | B 20266-- | B 20261-- | B 20252-- | 105,57 € | 36,92 kg Vol. 0,060 m ³ Nº bultos:3 | |
| B 204 | B 20468-- | B 20460-- | B 20454-- | B 20466-- | B 20461-- | B 20452-- | 112,00 € | 40,48 kg Vol. 0,066 m ³ Nº bultos:3 | |
| B 206 | B 20668-- | B 20660-- | B 20654-- | B 20666-- | B 20661-- | B 20652-- | 118,09 € | 44,07 kg Vol. 0,071 m ³ Nº bultos:3 | |
| B 208 | B 20868-- | B 20860-- | B 20854-- | B 20866-- | B 20861-- | B 20852-- | 130,63 € | 47,61 kg Vol. 0,077 m ³ Nº bultos:3 | |
| B 210 | B 21068-- | B 21060-- | B 21054-- | B 21066-- | B 21061-- | B 21052-- | 139,79 € | 50,93 kg Vol. 0,082 m ³ Nº bultos:3 | |

Ala.

| Modelo | | | | | | | P.V.P | Packing | |
|--------------|------------------|------------|------------|-------------|-----------|-----------|----------------|--|--|
| | blanco roto (68) | roble (60) | peral (54) | wengue (66) | gris (61) | haya(52) | | | |
| | | | | | | | | | |
| B 220 | B 22068-- | B 22060-- | B 22054-- | B 22066-- | B 22061-- | B 22052-- | 73,87 € | 21,74 kg Vol. 0,026 m ³ Nº bultos:3 | |
| B 230 | B 23068-- | B 23060-- | B 23054-- | B 23066-- | B 23061-- | B 23052-- | 63,72 € | 19,74 kg Vol. 0,026 m ³ Nº bultos:3 | |

Serie amba

Mesa recta 600mm. grosor 25mm.

| Modelo | | P.V.P | Packing |
|--------------|--|-----------------|--|
| | blanco roto (68) roble (60) peral (54) wengue (66) gris (61) haya(52) | | |
| | | | |
| B 212 | B 21268-- B 21260-- B 21254-- B 21266-- B 21261-- B 21252-- | 80,08 € | 23,31 kg Vol. 0,042 m ³ Nº bultos:4 |
| B 214 | B 21468-- B 21460-- B 21454-- B 21466-- B 21461-- B 21452-- | 91,04 € | 26,27 kg Vol. 0,047 m ³ Nº bultos:4 |
| B 216 | B 21668-- B 21660-- B 21654-- B 21666-- B 21661-- B 21652-- | 97,12 € | 29,07 kg Vol. 0,052 m ³ Nº bultos:4 |
| B 218 | B 21868-- B 21860-- B 21854-- B 21866-- B 21861-- B 21852-- | 103,26 € | 31,80 kg Vol. 0,057 m ³ Nº bultos:4 |

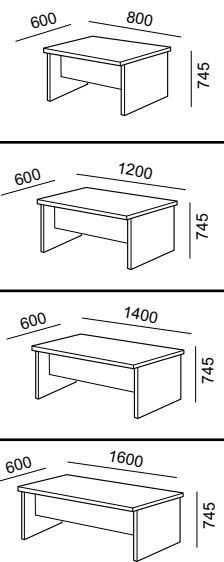

Al hacer el pedido indicar la mano del ángulo

Angulo y terminal luna.

| Modelo | | P.V.P | Packing |
|--------------|--|-----------------|--|
| | blanco roto (68) roble (60) peral (54) wengue (66) gris (61) haya(52) | | |
| | | | |
| C 290 | C 29068-- C 29060-- C 29054-- C 29066-- C 29061-- C 29052-- | 123,35 € | 14,91 kg Vol. 0,030 m ³ Nº bultos:2 |
| C 292 | C 29268-- C 29260-- C 29254-- C 29266-- C 29261-- C 29252-- | 118,71 € | 12,2 kg Vol. 0,024 m ³ Nº bultos:2 |
| C 294 | C 29468-- C 29460-- C 29454-- C 29466-- C 29461-- C 29452-- | 113,22 € | 10,18 kg Vol. 0,022 m ³ Nº bultos:2 |
| C 296 | C 29668 C 29660 C 29654 C 29666 C 29661 C 29652 | 97,97 € | 14,64 kg Vol. 0,024 m ³ Nº bultos:1 |

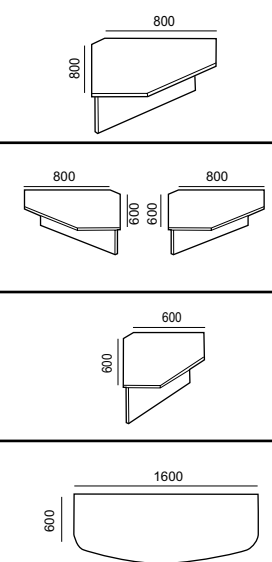

| | | | | |
|--------------|------------------------------|--|----------------|---|
| | | aluminio (98) blanco (91) grafito (97) | | |
| | | | | |
| C 502 | Pata pedestal cuadrada 50x50 | C 50298 C 50291 C 50297 | 24,96 € | 1,85 kg Vol. 0,010 m ³ Nº bultos:1 |

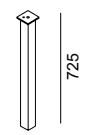

serie amba

Mesa compacta derecha.

| Modelo | | | | | | | P.V.P | Packing | |
|--------------|------------------|------------|------------|-------------|-----------|-----------|-----------------|--|--|
| | blanco roto (68) | roble (60) | peral (54) | wengue (66) | gris (61) | haya(52) | | | |
| | | | | | | | | | |
| B 250 | B 25068-- | B 25060-- | B 25054-- | B 25066-- | B 25061-- | B 25052-- | 147,54 € | 52,89 kg Vol. 0,092 m ³ Nº bultos:3 | |
| B 252 | B 25268-- | B 25260-- | B 25254-- | B 25266-- | B 25261-- | B 25252-- | 163,12 € | 57,22 kg Vol. 0,100 m ³ Nº bultos:3 | |
| B 254 | B 25468-- | B 25460-- | B 25454-- | B 25466-- | B 25461-- | B 25452-- | 178,07 € | 61,33 kg Vol. 0,108 m ³ Nº bultos:3 | |

Mesa compacta izquierda.

| Modelo | | | | | | | P.V.P | Packing | |
|--------------|------------------|------------|------------|-------------|-----------|-----------|-----------------|--|--|
| | blanco roto (68) | roble (60) | peral (54) | wengue (66) | gris (61) | haya(52) | | | |
| | | | | | | | | | |
| B 260 | B 26068-- | B 26060-- | B 26054-- | B 26066-- | B 26061-- | B 26052-- | 147,54 € | 52,89 kg Vol. 0,092 m ³ Nº bultos:3 | |
| B 262 | B 26268-- | B 26260-- | B 26254-- | B 26266-- | B 26261-- | B 26252-- | 163,12 € | 57,22 kg Vol. 0,100 m ³ Nº bultos:3 | |
| B 264 | B 26468-- | B 26460-- | B 26454-- | B 26466-- | B 26461-- | B 26452-- | 178,07 € | 61,33 kg Vol. 0,108 m ³ Nº bultos:3 | |

Separadores.

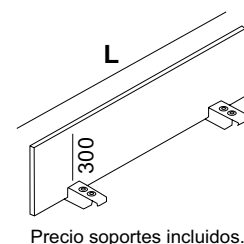

| Modelo | | | | | | | P.V.P | Packing | |
|--------------|------------------|------------|------------|-------------|-----------|----------|----------------|---|--------|
| | blanco roto (68) | roble (60) | peral (54) | wengue (66) | gris (61) | haya(52) | | | |
| | | | | | | | | | |
| C 701 | C 70168 | C 70160 | C 70154 | C 70166 | C 70161 | C 70152 | 55,52 € | 8,70 kg Vol. 0,027 m ³ Nº bultos:1 | L=1660 |
| C 702 | C 70268 | C 70260 | C 70254 | C 70266 | C 70261 | C 70252 | 54,62 € | 8,24 kg Vol. 0,026 m ³ Nº bultos:1 | L=1590 |
| C 703 | C 70368 | C 70360 | C 70354 | C 70366 | C 70361 | C 70352 | 46,59 € | 6,05 kg Vol. 0,017m ³ Nº bultos:1 | L=1050 |
| C 704 | C 70468 | C 70460 | C 70454 | C 70466 | C 70461 | C 70452 | 42,95 € | 4,85 kg Vol. 0,013 m ³ Nº bultos:1 | L=790 |

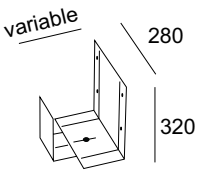
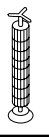
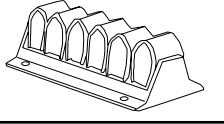
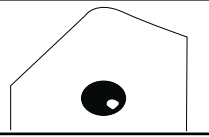
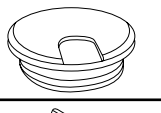
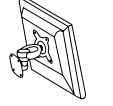

Accesorios.

| Modelo | | | | | | P.V.P | Packing | |
|--------------|--------------------------------|------------------|----------------|-----------------|---------------|----------------|---|---|
| | | aluminio (98) | blanco (91) | grafito (97) | negro (99) | | | |
| C 500 | Soporte CPU | C 50098 | C 50091 | C 50097 | | 29,53 € | 3,00 kg Vol. 0,020 m ³ Nº bultos:1 |  |
| C 501 | Gusano pasacables | C 50198 | C 50191 | | | 28,85 € | 0,64 kg Vol. 0,005 m ³ Nº bultos:1 |  |
| C 503 | Organizador pasacables | C 50398 | | | | 6,66 € | 0,07 kg Vol. 0,002 m ³ Nº bultos:1 |  |
| C 504 | Mecanizado y tapón pasacables. | C 50498 | | | C 50499 | 16,10 € | segun tapa Vol. segun tapa Nº bultos:1 |  |
| C 505 | Tapón pasacables | C 50598 | | | C 50599 | 2,75 € | 0,02 kg Vol. 0,001 m ³ Nº bultos:1 |  |
| C 506 | Soporte monitor | C 50698 | | | | 87,43 € | 1,50 kg Vol. 0,020 m ³ Nº bultos:1 |  |

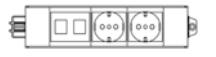
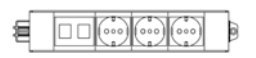
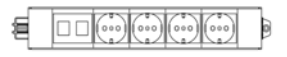
Electrificaciones.

| Modelo | | P.V.P | Packing | |
|--------------------|--|----------------|-----------|---|
| 33101002-98 | 2 tomas Schuko + voz + datos, aluminio | 90,16 € | 210x50x48 |  |
| 33101002-00 | 2 tomas Schuko + voz + datos, negro | 90,16 € | 210x50x48 | |
| 33101003-98 | 3 tomas Schuko + voz + datos, aluminio | 91,51 € | 280x50x48 |  |
| 33101003-00 | 3 tomas Schuko + voz + datos, negro | 91,51 € | 280x50x48 | |
| 33101004-98 | 4 tomas Schuko + voz + datos, aluminio | 95,67 € | 350x50x48 |  |
| 33101004-00 | 4 tomas Schuko + voz + datos, negro | 95,67 € | 350x50x48 | |
| 01000003 | cable conexión a la red eléctrica | 21,48 € | 2 metros |  |

serie amba

Esquemas de unión.

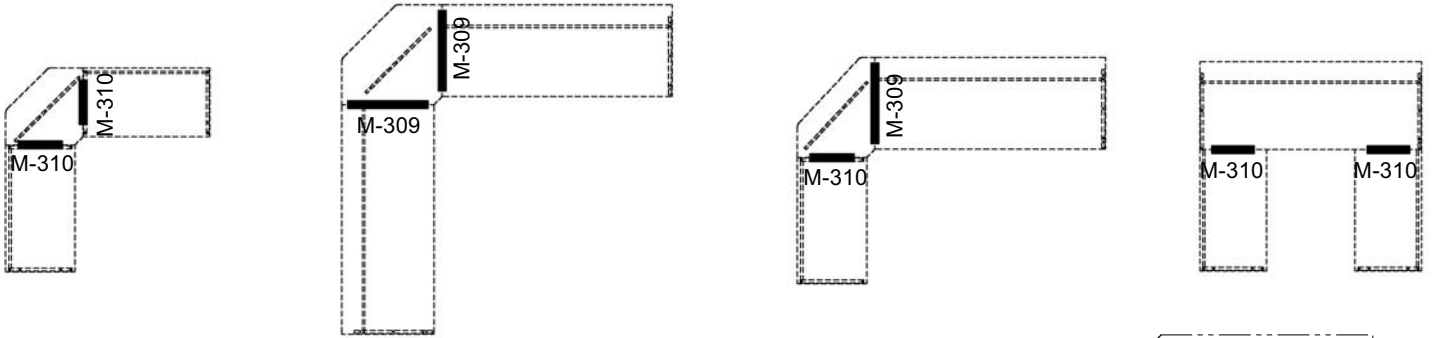

CHAPAS DE UNION

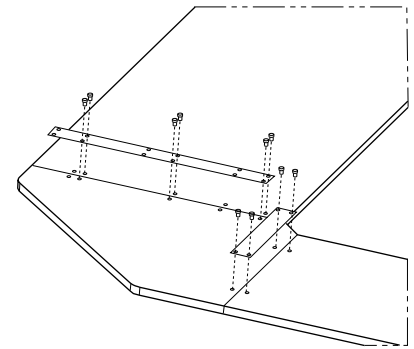
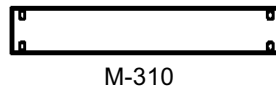
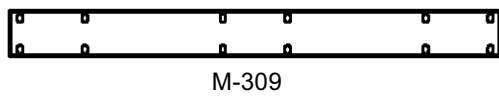

Composiciones tipo.

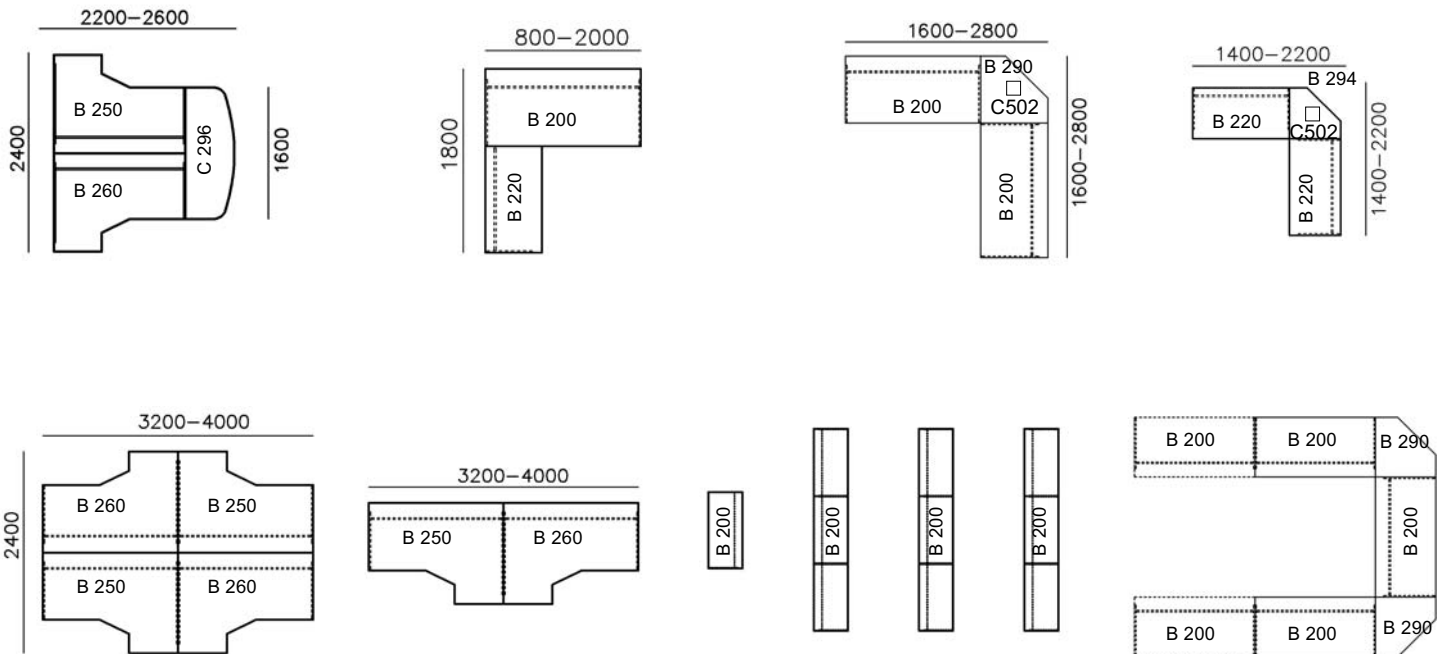

Características técnicas

**Cerradura
amaestrada**
en todas las
referencias

**Cajón con cubeta
monoblock con
separador**

Cajón archivo.

- Carpetas DIN-A4.
- Adaptador opcional para carpetas de formatos especiales.

Guias metálicas
extracción total.

Rueda estabilizadora
en los cajones de archivo



bloque melamina



bloque metálico

acabados

Laminado

Recubrimiento laminado sobre tablero de 19mm. de grosor. Cantos de ABS de 1mm. de espesor, aplicado con cola termofusible y redondeado.



blanco roto
(68)



roble
(60)



peral
(54)



wengue
(66)



gris
(61)



haya
(52)



blanco
(68)



grafito
(62)



aluminio
(67)

sólo para estructura

Metálico



aluminio RAL 9006
(98)



blanco RAL 9003
(91)

Desviaciones de color lógicas del proceso de impresión.

Programa

bloque rodante melamina.

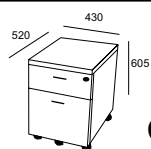

C 100

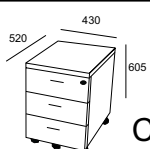

C 101

bloque colgante melamina.

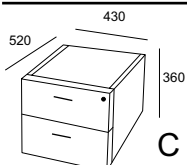

C 102

bloque rodante metálico.

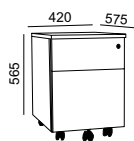

L 100

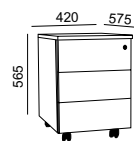

L 101

bloque pedestal melamina.

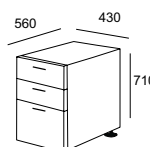

C 103

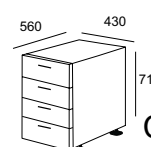

C 104

Bloques madera

Código de producto.

El código final del pedido vendrá determinado por los cinco dígitos que vienen en las tablas inferiores, más los correspondientes.

al acabado de la estructura que aparecen en la tabla de la derecha.

EJEMPLO :

Bloque rodante de melamina Blanco : C 100 **68** Estructura Todos su color : C100 68 **68**

Bloque colgante de melamina Blanco : C 102 **68** Estructura grafito : C100 68 **62**

Acabados estructura melamina.



blanco
(68)



grafito
(62)



aluminio
(67)

Bloque rodante.

| Modelo | | | | | | | P.V.P. | Packing |
|--------------|------------------|------------|------------|-------------|-----------|-----------|-----------------|--|
| | blanco roto (68) | roble (60) | peral (54) | wengue (66) | gris (61) | haya(52) | | |
| | | | | | | | | |
| C 100 | C 10068-- | C 10060-- | C 10054-- | C 10066-- | C 10061-- | C 10052-- | 138,45 € | 23,75 kg Vol. 0,121 m ³ Nº bultos:1 |
| C 101 | C 10168-- | C 10160-- | C 10154-- | C 10166-- | C 10161-- | C 10152-- | 130,41 € | 24,10 kg Vol. 0,121 m ³ Nº bultos:1 |

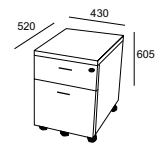

Bloque colgante.

| Modelo | | | | | | | P.V.P. | packing |
|--------------|------------------|------------|------------|-------------|-----------|-----------|----------------|--|
| | blanco roto (68) | roble (60) | peral (54) | wengue (66) | gris (61) | haya(52) | | |
| | | | | | | | | |
| C 102 | C 10268-- | C 10260-- | C 10254-- | C 10266-- | C 10261-- | C 10252-- | 93,60 € | 15,60 kg Vol. 0,082 m ³ Nº bultos:1 |

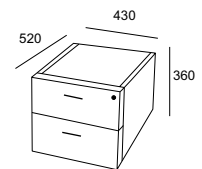

Bloque pedestal.

| Modelo | | | | | | | P.V.P. | packing |
|--------------|------------------|------------|------------|-------------|-----------|-----------|-----------------|--|
| | blanco roto (68) | roble (60) | peral (54) | wengue (66) | gris (61) | haya(52) | | |
| | | | | | | | | |
| C 103 | C 10368-- | C 10360-- | C 10354-- | C 10366-- | C 10361-- | C 10352-- | 195,22 € | 25,10 kg Vol. 0,174 m ³ Nº bultos:1 |
| C 104 | C 10468-- | C 10460-- | C 10454-- | C 10466-- | C 10461-- | C 10452-- | 195,68 € | 25,10 kg Vol. 0,174 m ³ Nº bultos:1 |

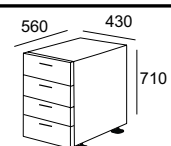
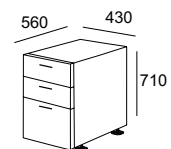

Bloques metálicos

Código de producto.

El código final del pedido vendrá determinado por los cinco dígitos que vienen en las tablas inferiores, más los correspondientes.

al acabado de la estructura que aparecen en la tabla de la derecha.

EJEMPLO :

Bloque 1 cajón + archivo metálico frontal metálico Blanco : L 100 68

Estructura Blanco : C100 68 91

Bloque 1 cajón + archivo metálico frontal metálico Blanco : L 100 91

Estructura Blanco : L 100 91 91

Acabados estructura metálica.



blanco
(68)



aluminio
(67)

Bloque 1 cajón + archivo.

| Modelo | | P.V.P. | | Packing | |
|--------|--|--------|--|--|--|
| | | | | 20,8 kg Vol. 0.14 m ³ Nº bultos:1 | |
| | | | | todo metálico 208,00 € | |
| | | | | frontal melamina 236,37 € | |

| metálico | | frontal laminado | | | | |
|---------------|-------------|------------------|------------|------------|-------------|----------|
| aluminio (98) | blanco (91) | blanco roto (68) | roble (60) | peral (54) | wengue (66) | haya(52) |
| | | | | | | |
| L1009898 | L1009191 | L10068-- | L10060-- | L10054-- | L10066-- | L10052-- |

todo metal o
frontal laminado

Bloque 3 cajones

| Modelo | | P.V.P. | | Packing | |
|--------|--|--------|--|--|--|
| | | | | 20,8 kg Vol. 0.14 m ³ Nº bultos:1 | |
| | | | | todo metálico 208,00 € | |
| | | | | melamina 236,37 € | |

| metálico | | frontal laminado | | | | |
|---------------|-------------|------------------|------------|------------|-------------|----------|
| aluminio (98) | blanco (91) | blanco roto (68) | roble (60) | peral (54) | wengue (66) | haya(52) |
| | | | | | | |
| L1019898 | L1019191 | L10168-- | L10160-- | L10154-- | L10166-- | L10152-- |

todo metal o
frontal laminado

Bandeja porta-lapiceros

| Modelo | | P.V.P. | | packing | |
|--------|--|----------|--|--|--|
| L 149 | | L1490000 | | 8,19 € | |
| | | | | 0,40 kg Vol. 0,03 m ³ Nº bultos:1 | |

sobretapa para bloque pedestal C 103, C 104.

| Modelo | | P.V.P. | | packing | |
|--------|--|--------|--|---|--|
| | | | | 5,01 kg Vol. 0,024 m ³ Nº bultos:1 | |
| | | | | 20,03 € | |
| | | | | 6,91 kg Vol. 0,033 m ³ Nº bultos:1 | |
| | | | | 22,87 € | |

| blanco roto (68) | roble (60) | peral (54) | wengue (66) | gris (61) | haya(52) |
|------------------|------------|------------|-------------|-----------|----------|
| | | | | | |
| C 10568 | C 10560 | C 10554 | C 10566 | C 10561 | C 10552 |
| C 10668 | C 10660 | C 10654 | C 10666 | C 10661 | C 10652 |

Características técnicas



SUPERFICIE: Tablero laminado de 25mm.

ESTRUCTURA: Basada en laterales de tablero laminado de 25mm o Tubo metalico 110mm con base de 580mm y 6mm de espesor.

Acabados

Laminado

Recubrimiento laminado sobre tablero de 25mm. de grosor. Cantos de ABS de 2mm. de espesor, aplicado con cola termofusible y redondeado.



blanco roto
(68)



roble
(60)



peral
(54)



wengue
(66)



gris
(61)



haya
(52)



grafito
(62)



aluminio
(67)

Metálico

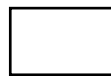

blanco
(91)
ral 9003



aluminio
(98)
ral 9006



grafito
(97)
ral personalizado

Desviaciones de color lógicas del proceso de impresión.

Programa

Mesas de juntas amba-krono.

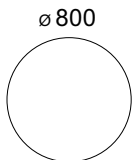

C 400-401

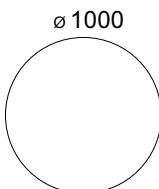

C 402-403

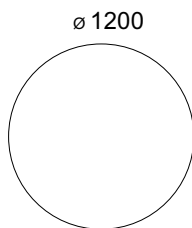

C 404-405

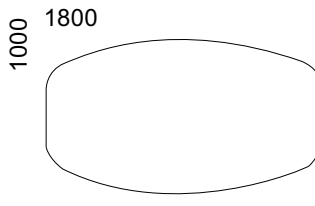

C 406-407

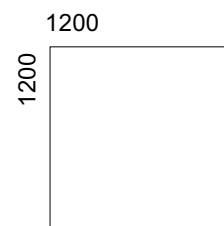

C 408-409

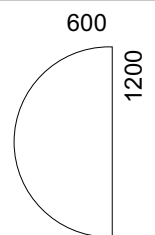

C 410

Serie amba

Código del producto:

El código final del pedido vendrá determinado por los cinco dígitos que vienen en las tablas inferiores, más los correspondientes.

al acabado de la estructura que aparecen en la tabla de la derecha.

EJEMPLO:

Mesa circular Ø800 blanca: **C 400 68 --**, TODO SU COLOR: **C 4006868**

Mesa circular Ø1000 blanca: **C 402 68 --**, con estructura ALUMINIO: **C 402686**

ACABADOS ESTRUCTURA

Todo Su Color (68)(60)(54)
(66)(61)(69) aluminio (67) grafito (62) blanco (68)



C----XX C ----67 C ----62 C ----68

Mesa de juntas estructura madera.

| Modelo | blanco roto (68) roble (60) peral (54) wengue (66) gris (61) haya(52) | | | | | | P.V.P. | Packing | |
|--------------|--|-----------|-----------|-----------|-----------|-----------|-----------------|--|--|
| C 400 | C 40068-- | C 40060-- | C 40054-- | C 40066-- | C 40061-- | C 40052-- | 126,17 € | 24,85 kg Vol. 0,075 m ³ Nº bultos:2 | |
| C 402 | C 40268-- | C 40260-- | C 40254-- | C 40266-- | C 40261-- | C 40252-- | 134,60 € | 29,30 kg Vol. 0,085 m ³ Nº bultos:2 | |
| C 404 | C 40468-- | C 40460-- | C 40454-- | C 40466-- | C 40461-- | C 40452-- | 138,29 € | 34,61 kg Vol. 0,108 m ³ Nº bultos:2 | |
| C 406 | C 40668-- | C 40660-- | C 40654-- | C 40666-- | C 40661-- | C 40652-- | 176,85 € | 62,13 kg Vol. 0,120 m ³ Nº bultos:3 | |
| C 408 | C 40868-- | C 40860-- | C 40854-- | C 40866-- | C 40861-- | C 40852-- | 145,73 € | 39,37 kg Vol. 0,108 m ³ Nº bultos:2 | |
| C 410 | C 41068-- | C 41060-- | C 41054-- | C 41066-- | C 41061-- | C 41052-- | 72,23 € | 12,92 kg Vol. 0,060 m ³ Nº bultos:2 | |

En este tipo de composiciones la veta de la madera de las distintas tapas no coincidirá.

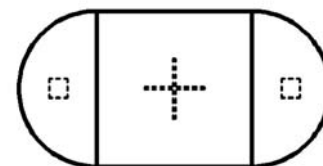
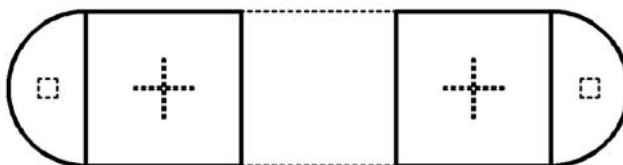

Características técnicas

SUPERFICIE: Tablero laminado de 25mm.

ESTRUCTURA: Basada en laterales de tablero laminado de 19mm.

PIES: Protección antihumedad de poliestireno.

Bisagras regulables, en altura y profundidad

Cuerpo de madera laminada de 19 mm.

Estantes laminados de de 25mm/19mm.

Puertas laminadas de 19 mm.

Tiradores de PVC.

Cerradura de sobreponer (excepto puertas de cristal y armarios de 2,40 de altura).

Puertas de cristal con marco de aluminio y cristal color mate de 4mm.

Guías de archivadores de extracción total con sistema antivuelco.



Detalles

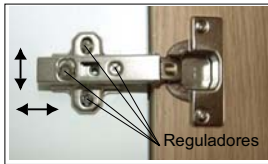

Bisagras regulables.



Tiradores de PVC.



Puertas de cristal.



Guías de extracción total.

Laminado

Recubrimiento laminado sobre tablero de 25mm. de grosor.

Cantos de ABS de 2mm. de espesor, aplicado con cola termofusible y redondeado.



blanco roto
(68)



roble
(60)



peral
(54)



wengue
(66)



gris
(61)



haya
(52)

(*) Disponible sólo hasta fin de existencias.

Estructura

Recubrimiento laminado sobre tablero de 19mm. de grosor.

Cantos de ABS de 1mm. de espesor, aplicado con cola termofusible y redondeado.



grafito
(62)



aluminio
(67)



blanco
(68)

Desviaciones de color lógicas del proceso de impresión.

Programa

Armarios.

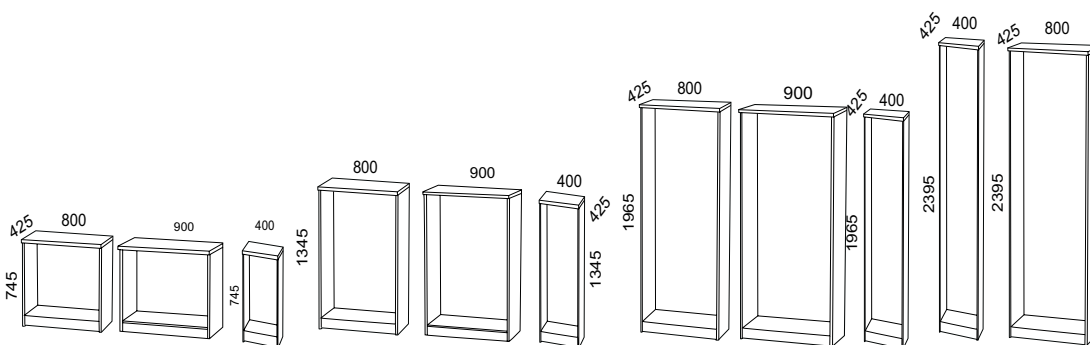

estanterías.

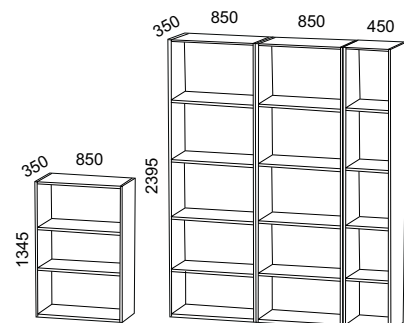

Armarios y estanterías









Armario altura 745 mm.

| Modelo | | | | | | | P.V.P. | Packing |
|--------------|------------------|------------|------------|-------------|-----------|-----------|-----------------|---|
| | blanco roto (68) | roble (60) | peral (54) | wengue (66) | gris (61) | haya(52) | | |
| | | | | | | | | |
| C 300 | C 30068-- | C 30060-- | C 30054-- | C 30066-- | C 30061-- | C 30052-- | 82,82 € | 22,65 kg Vol. 0,050 m ³ Nº bultos:3 armario vacío |
| C 301 | C 30168-- | C 30160-- | C 30154-- | C 30166-- | C 30161-- | C 30152-- | 127,19 € | 29,05 kg Vol. 0,065 m ³ Nº bultos:4 armario con puertas |
| C 302 | C 30268-- | C 30260-- | C 30254-- | C 30266-- | C 30261-- | C 30252-- | 378,72 € | 49,40 kg Vol. 0,271 m ³ Nº bultos:1 armario con archivadores |
| C 303 | C 30368-- | C 30360-- | C 30354-- | C 30366-- | C 30361-- | C30352--- | 67,83 € | 15,06 kg Vol. 0,032 m ³ Nº bultos:3 armario reducido vacío |
| C 304 | C 30468-- | C 30460-- | C 30454-- | C 30466-- | C 30461-- | C 30452-- | 99,00 € | 18,26 kg Vol. 0,040 m ³ Nº bultos:3 armario reducido con puerta |
| C 305 | C 30568-- | C 30560-- | C 30554-- | C 30566-- | C 30561-- | C 30552-- | 259,23 € | 59,76 kg Vol. 0,476 m ³ Nº bultos:1 armario CRD |
| C 370 | C 37068-- | C 37060-- | C 37054-- | C 37066-- | C 37061-- | C 37052-- | 90,56 € | 22,65 kg Vol. 0,050 m ³ Nº bultos:3 armario vacío |
| C 371 | C 37168-- | C 37160-- | C 37154-- | C 37166-- | C 37161-- | C 37152-- | 135,37 € | 29,05 kg Vol. 0,065 m ³ Nº bultos:4 armario con puertas |

Los armarios no incluyen los estantes pág 19.

Armarios y estanterías

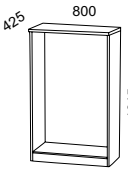
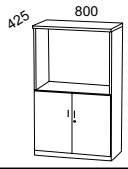
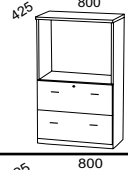
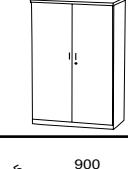
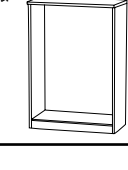
Armario altura 1345 mm.

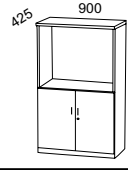
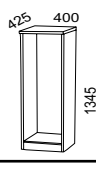
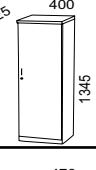
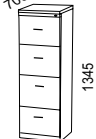
| Modelo | | | | | | | P.V.P. | Packing | |
|--------------|---|---|---|---|---|---|-----------------|--|---|
| | blanco roto (68) | roble (60) | peral (54) | wengue (66) | gris (61) | haya(52) | | | |
| |  |  |  |  |  |  | | | |
| C 310 | C 31068-- | C 31060-- | C 31054-- | C 31066-- | C 31061-- | C 31052-- | 106,31 € | 32,01 kg Vol. 0,069 m ³ Nº bultos:3 |  armario vacío |
| C 311 | C 31168-- | C 31160-- | C 31154-- | C 31166-- | C 31161-- | C 31152-- | 167,95 € | 44,44 kg Vol. 0,094 m ³ Nº bultos:5 |  armario con puertas bajas |
| C 312 | C 31268-- | C 31260-- | C 31254-- | C 31266-- | C 31261-- | C 31252-- | 434,14 € | 64,49 kg Vol. 0,485 m ³ Nº bultos:1 |  armario con 2 archivadores |
| C 313 | C 31368-- | C 31360-- | C 31354-- | C 31366-- | C 31361-- | C 31352-- | 176,82 € | 46,47 kg Vol. 0,098 m ³ Nº bultos:4 |  armario con puertas |
| C 372 | C 37268-- | C 37260-- | C 37254-- | C 37266-- | C 37261-- | C 37252-- | 118,80 € | 35,01 kg Vol. 0,069 m ³ Nº bultos:3 |  armario vacío |
| C373 | C 37368-- | C 37360-- | C 37354-- | C 37366-- | C 37361-- | C 37352-- | 205,96 | 44,47 kg Vol. 0,098 m ³ Nº bultos:4 |  armario con puertas |
| C 374 | C 37468-- | C 37460-- | C 37454-- | C 37466-- | C 37461-- | C 37452-- | 203,90 € | 46,47 kg Vol. 0,099 m ³ Nº bultos:5 |  armario con puertas bajas |
| C 314 | C 31468-- | C 31460-- | C 31454-- | C 31466-- | C 31461-- | C 31452-- | 85,70 € | 22,80 kg Vol. 0,048 m ³ Nº bultos:3 |  armario reducido vacío |
| C 315 | C 31568-- | C 31560-- | C 31554-- | C 31566-- | C 31561-- | C 31552-- | 130,10 € | 29,03 kg Vol. 0,063 m ³ Nº bultos:4 |  armario reducido con puertas |
| C 316 | C 31668-- | C 31660-- | C 31654-- | C 31666-- | C 31661-- | C 31652-- | 403,46 € | 62,04 kg Vol. 0,467 m ³ Nº bultos:1 |  archivador vertical con 4 cajones duplex |

Armarios y estanterías

Armario altura 1965 mm.

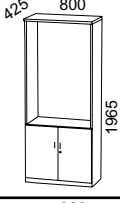
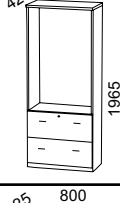
| Modelo | | | | | | | P.V.P. | Packing | | |
|--------------|---|---|---|---|---|---|-----------------|--|---|----------------------------------|
| | blanco roto (68) | roble (60) | peral (54) | wengue (66) | gris (61) | haya(52) | | | | |
| |  |  |  |  |  |  | | | | |
| C 320 | C 32068-- | C 32060-- | C 32054-- | C 32066-- | C 32061-- | C 32052-- | 137,88 € | 41,69 kg Vol. 0,088 m ³ Nº bultos:3 |  | armario vacío |
| C 321 | C 32168-- | C 32160-- | C 32154-- | C 32166-- | C 32161-- | C 32152-- | 188,50 € | 54,11 kg Vol. 0,113 m ³ Nº bultos:5 |  | armario con puertas bajas |
| C 322 | C 32268-- | C 32260-- | C 32254-- | C 32266-- | C 32261-- | C 32252-- | 458,41 € | 74,04 kg Vol. 0,706 m ³ Nº bultos:1 |  | armario con 2 archivadores |
| C 323 | C 32368-- | C 32360-- | C 32354-- | C 32366-- | C 32361-- | C 32352-- | 210,23 € | 60,41 kg Vol. 0,103 m ³ Nº bultos:4 |  | armario con puertas |
| C 375 | C 37568-- | C 37560-- | C 37554-- | C 37566-- | C 37561-- | C 37552-- | 138,77 € | 43,69 kg Vol. 0,088 m ³ Nº bultos:3 |  | armario vacío |
| C 376 | C 37668-- | C 37660-- | C 37654-- | C 37666-- | C 37661-- | C 37652-- | 236,85 € | 63,41 kg Vol. 0,103 m ³ Nº bultos:4 |  | armario con puertas |
| C 377 | C 37768-- | C 37760-- | C 37754-- | C 37766-- | C 37761-- | C 37752-- | 212,10 € | 56,11 kg Vol. 0,120 m ³ Nº bultos 5 |  | armario con puertas bajas |

Los armarios no incluyen los estantes.19

Armarios y estanterías

Armario altura 1965 mm.

| Modelo | | | | | | | P.V.P. | Packing | | |
|--------------|------------------|------------|------------|-------------|-----------|-----------|-----------------|--|--|------------------------------------|
| | blanco roto (68) | roble (60) | peral (54) | wengue (66) | gris (61) | haya(52) | | | | |
| | | | | | | | | | | |
| C 324 | C 32468-- | C 32460-- | C 32454-- | C 32466-- | C 32461-- | C 32452-- | 106,46 € | 30,81 kg Vol. 0,064 m ³ Nº bultos:3 | | armario reducido vacío |
| C 325 | C 32568-- | C 32560-- | C 32554-- | C 32566-- | C 32561-- | C 32552-- | 142,08 € | 34,00 kg Vol. 0,079 m ³ Nº bultos:5 | | armario reducido con puertas bajas |
| C 326 | C 32668-- | C 32660-- | C 32654-- | C 32666-- | C 32661-- | C 32652-- | 151,98 € | 37,04 kg Vol. 0,079 m ³ Nº bultos:4 | | armario reducido con puertas |



Armario altura 2395 mm.

| Modelo | | | | | | | P.V.P. | Packing | | |
|--------------|------------------|------------|------------|-------------|-----------|-----------|-----------------|--|--|------------------------------------|
| | blanco roto (68) | roble (60) | peral (54) | wengue (66) | gris (61) | haya(52) | | | | |
| | | | | | | | | | | |
| C 330 | C 33068-- | C 33060-- | C 33054-- | C 33066-- | C 33061-- | C 33052-- | 164,16 € | 50,79 kg Vol. 0,110 m ³ Nº bultos:3 | | armario vacío |
| C 331 | C 33168-- | C 33160-- | C 33154-- | C 33166-- | C 33161-- | C 33152-- | 261,23 € | 76,60 kg Vol. 0,130 m ³ Nº bultos:4 | | armario con puertas |
| C 332 | C 33268-- | C 33260-- | C 33254-- | C 33266-- | C 33261-- | C 33252-- | 147,68 € | 35,55 kg Vol. 0,077 m ³ Nº bultos:3 | | armario reducido vacío |
| C 333 | C 33368-- | C 33360-- | C 33354-- | C 33366-- | C 33361-- | C 33352-- | 182,04 € | 49,79 kg Vol. 0,085 m ³ Nº bultos:5 | | armario reducido con puertas bajas |

Los armarios no incluyen los estantes pág 19.

Armarios y estanterías

Armario puertas de cristal.

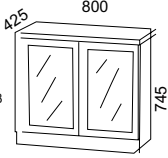
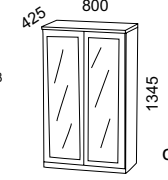
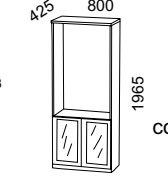
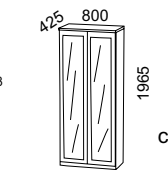
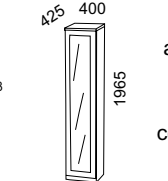
| Modelo | | | | | | | P.V.P. | Packing |
|--------------|---|---|---|---|---|---|-----------------|---|
| | blanco roto (68) | roble (60) | peral (54) | wengue (66) | gris (61) | haya(52) | | |
| |  |  |  |  |  |  | | |
| C 340 | C 34068-- | C 34060-- | C 34054-- | C 34066-- | C 34061-- | C 34052-- | 274,39 € | 29,05 kg Vol. 0,065 m ³ Nº bultos:5  armario bajo con puertas de cristal con marco de aluminio color cristal mate 4mm |
| C 341 | C 34168-- | C 34160-- | C 34154-- | C 34166-- | C 34161-- | C 34152-- | 364,34 € | 44,47 kg Vol. 0,098 m ³ Nº bultos:5  armario mediano con puertas de cristal con marco de aluminio color cristal mate 4mm |
| C 342 | C 34268-- | C 34260-- | C 34254-- | C 34266-- | C 34261-- | C 34252-- | 350,69 € | 54,11 kg Vol. 0,113 m ³ Nº bultos:6  armario alto con puertas de cristal con marco de aluminio color cristal mate 4mm |
| C 343 | C 34368-- | C 34360-- | C 34354-- | C 34366-- | C 34361-- | C 34352-- | 465,89 € | 60,41 kg Vol. 0,103 m ³ Nº bultos:5  armario alto con puertas de cristal con marco de aluminio color cristal mate 4mm |
| C 344 | C 34468-- | C 34460-- | C 34454-- | C 34466-- | C 34461-- | C 34452-- | 331,79 € | 37,04 kg Vol. 0,079 m ³ Nº bultos:4  armario alto reducido con puertas de cristal con marco de aluminio color cristal mate 4mm |

Las puertas de cristal no llevarán cerradura

Los armarios no incluyen los estantes pág 32.









Armarios y estanterías

Estanterías 1345-2395.

| Modelo | | | | | | | P.V.P. | Packing | |
|---|------------------|------------|------------|-------------|-----------|-----------|-----------------|--|--|
| | blanco roto (68) | roble (60) | peral (54) | wengue (66) | gris (61) | haya(52) | | | |
| | | | | | | | | | |
| C 350 juego lateral estantería 2395-800 | C 35068-- | C 35060-- | C 35054-- | C 35066-- | C 35061-- | C 35052-- | 108,48 € | 34,76 kg Vol. 0,078 m ³ Nº bultos:3 | |
| C 351 central extension estantería 2395-800 | C 35168-- | C 35160-- | C 35154-- | C 35166-- | C 35161-- | C 35152-- | 53,67 € | 17,38 kg Vol. 0,039 m ³ Nº bultos:2 | |
| C 352 juego lateral estantería 1345-800 | C 35268-- | C 35260-- | C 35254-- | C 35266-- | C 35261-- | C 35252-- | 60,09 € | 20,86 kg Vol. 0,026 m ³ Nº bultos:3 | |
| C 353 central extension estantería 1345-800 | C 35368-- | C 35360-- | C 35354-- | C 35366-- | C 35361-- | C 35352-- | 31,79 € | 11,47 kg Vol. 0,018 m ³ Nº bultos:2 | |
| C 354 juego lateral estantería 2395-400 | C 35468-- | C 35460-- | C 35454-- | C 35466-- | C 35461-- | C 35452-- | 105,16 € | 31,98 kg Vol. 0,071 m ³ Nº bultos:3 | |
| C 355 central extension estantería 2395-400 | C 35568-- | C 35560-- | C 35554-- | C 35566-- | C 35561-- | C 35552-- | 53,43 € | 16,86 kg Vol. 0,037 m ³ Nº bultos:2 | |
| C 356 juego lateral estantería 1345-400 | C 35668-- | C 35660-- | C 35654-- | C 35666-- | C 35661-- | C 35652-- | 59,18 € | 20,34 kg Vol. 0,024 m ³ Nº bultos:2 | |
| C 357 central extension estantería 1345-400 | C 35768-- | C 35760-- | C 35754-- | C 35766-- | C 35761-- | C 35752-- | 30,77 € | 10,95 kg Vol. 0,017 m ³ Nº bultos:2 | |
| C 358 estante para estantería ancho 800 | C 35868-- | C 35860-- | C 35854-- | C 35866-- | C 35861-- | C 35852-- | 20,06 € | 4,24 kg Vol. 0,015 m ³ Nº bultos:1 | |
| C 359 estante para estantería ancho 400 | C 35968-- | C 35960-- | C 35954-- | C 35966-- | C 35961-- | C 35952-- | 13,31 € | 2,12 kg Vol. 0,008 m ³ Nº bultos:1 | |

Armarios y estanterías

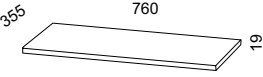
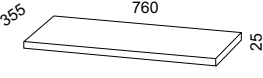
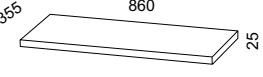
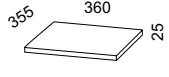
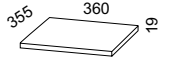
Accesorios.

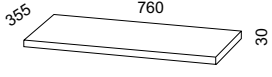
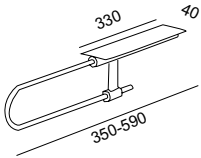
| Modelo | | | | | | | P.V.P. | Packing | |
|---|---|---|---|---|---|---|----------------|---|---|
| | blanco roto (68) | roble (60) | peral (54) | wengue (66) | gris (61) | haya(52) | | | |
| |  |  |  |  |  |  | | | |
| C 360 estante de melamina de 19mm para armarios | C 36068 | C 36060 | C 36054 | C 36066 | C 36061 | C 36052 | 12,26 € | 3,52 kg Vol. 0,008 m ³ Nº bultos:1 |  |
| C 361 estante de melamina de 25 mm para armarios | C 36168 | C 36160 | C 36154 | C 36166 | C 36161 | C 36152 | 15,27 € | 5,40 kg Vol. 0,008 m ³ Nº bultos:1 |  |
| C 366 estante de melamina de 25mm para armarios de 900 | C 36668 | C 36660 | C 36654 | C 36666 | C 36661 | C 36652 | 19,00 € | 6,20 kg Vol. 0,008 m ³ Nº bultos:1 |  |
| C 363 estante de melamina de 25mm para armarios reducidos | C 36368 | C 36360 | C 36354 | C 36366 | C 36361 | C 36352 | 9,27 € | 2,60 kg Vol. 0,004 m ³ Nº bultos:1 |  |
| C 362 estante de melamina de 19mm para armarios reducidos | C 36268 | C 36260 | C 36254 | C 36266 | C 36261 | C 36252 | 7,89 € | 1,70 kg Vol. 0,004 m ³ Nº bultos:1 |  |
| | | | | | | | | | |
| | | | aluminio (98) RAL 9006 | negro (99) | | | | | |
| | | |  |  | | | | | |
| C 364 estante metalico para colgar carpetas para armarios | C 36498 | C 36499 | | | | | 18,08 € | 1,50 kg Vol. 0,002 m ³ Nº bultos:1 |  |
| C 365 portaperchas metalico extensible | | | | | | | 11,96 € | 0,50 kg Vol. 0,002 m ³ Nº bultos:1 |  |