

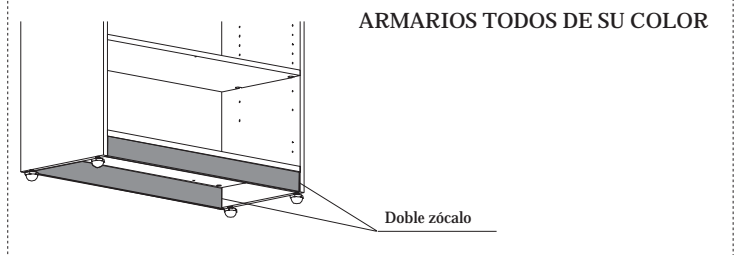

ECO

Acabados

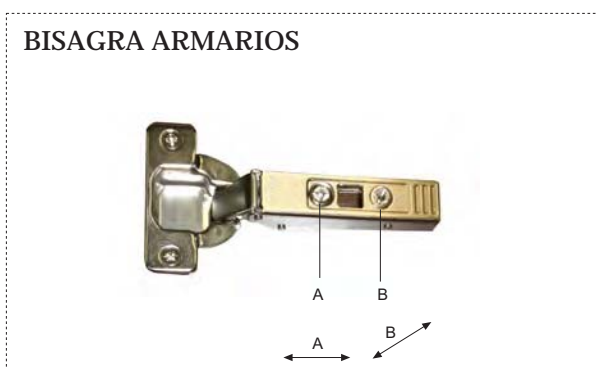

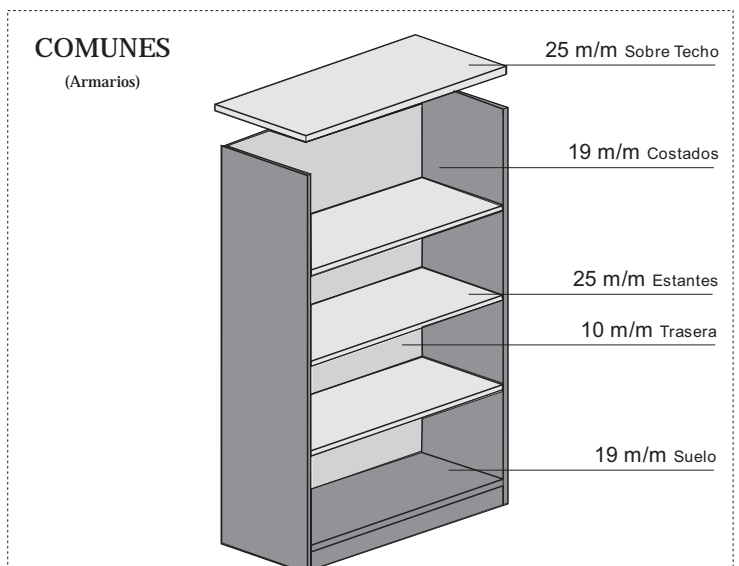
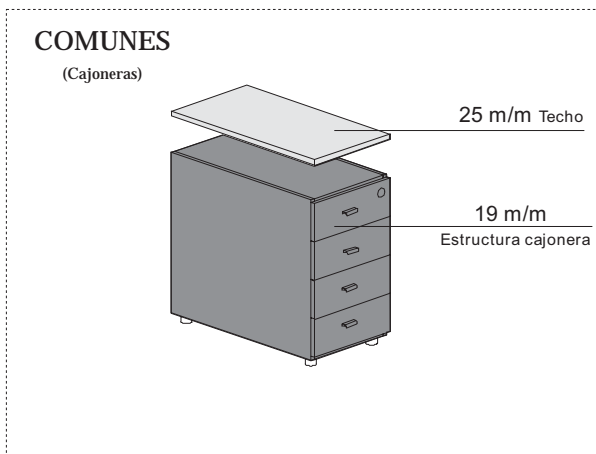
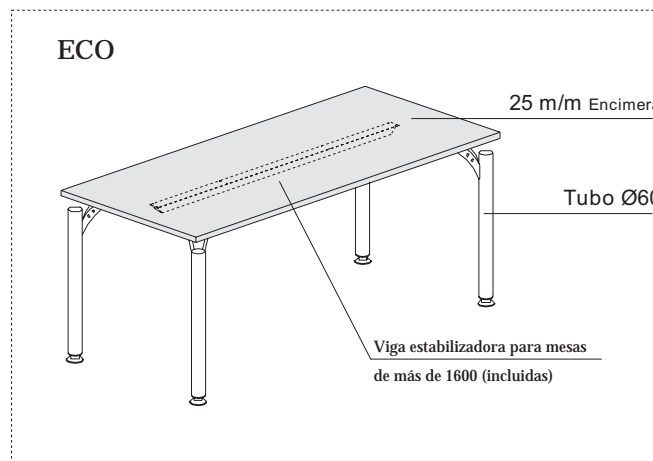
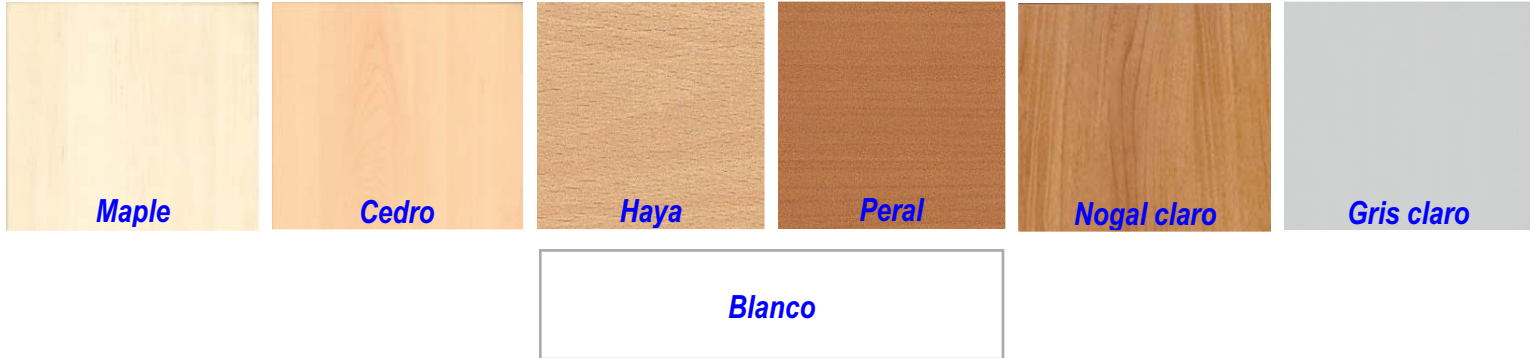

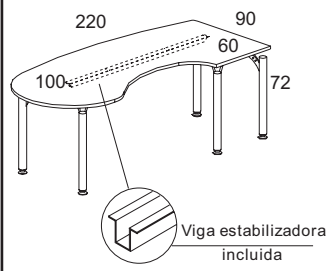
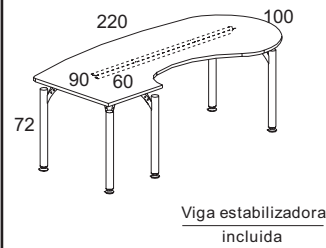
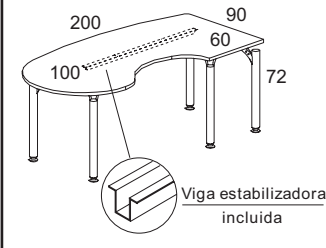
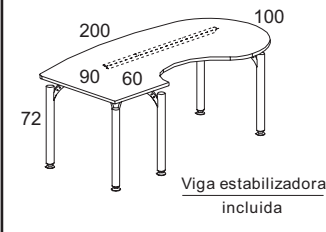
ACABADOS GRUPO 1							ACABADOS GRUPO 2		
	NC	MP	BL	GC	HY	PR	AL		
Colores	NOGAL CLARO	MAPLE	BLANCO	GRIS CLARO	HAYA	PERAL	ALUMINIO		
	-Encimera de mesa		-Lateral de mesa		- Cajoneras		- Faldones		
								-Pie metalico	

DESCRIPCIÓN / MEDIDAS	ACABADOS GRUPO 1	REF.	ACABADOS GRUPO 2		KG	M ³	€
 <p>COMPACTA DIRECCIONAL 220D.</p>	NC MP BL GC HY PR	ECO450D	AL	3	45,40	0,104	294,50
 <p>COMPACTA DIRECCIONAL 220I.</p>	NC MP BL GC HY PR	ECO450I	AL	3	45,40	0,104	294,50
 <p>COMPACTA DIRECCIONAL 200D.</p>	NC MP BL GC HY PR	ECO451D	AL	3	43,75	0,094	288,50
 <p>COMPACTA DIRECCIONAL 200I.</p>	NC MP BL GC HY PR	ECO451I	AL	3	43,75	0,094	288,50

- Esta línea opera acorde la norma UNE-EN 527-1 de dimensiones de Mesas de Trabajo regulables en altura y entra en el intervalo de medidas según la Normativa Holandesa NEN 2449.

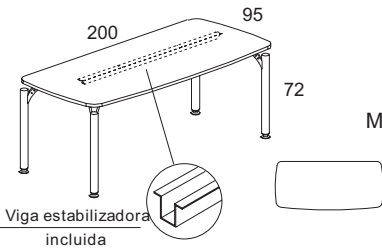
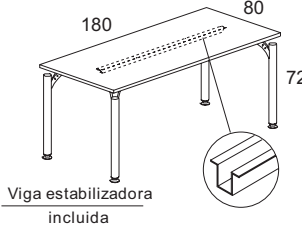
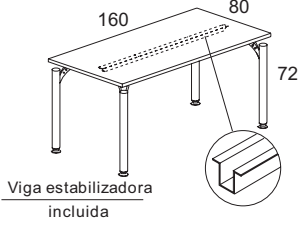
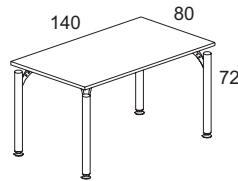
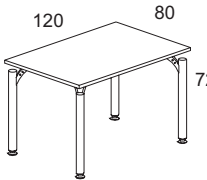
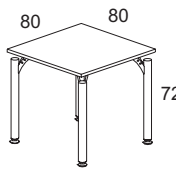
REGULABLE 13cm.

DESCRIPCIÓN / MEDIDAS	ACABADOS GRUPO 1	REF.	ACABADOS GRUPO 2		KG	M ³	€
 <p>MESA CURVA 200</p>	NC MP BL GC HY PR	ECO400C	AL	3	43,80	0,092	256,50
 <p>MESA 180</p>	NC MP BL GC HY PR	ECO501	AL	3	39,00	0,082	223,00
 <p>MESA 160</p>	NC MP BL GC HY PR	ECO502	AL	3	35,80	0,077	214,00
 <p>MESA 140</p>	NC MP BL GC HY PR	ECO503	AL	2	30,20	0,069	178,50
 <p>MESA 120</p>	NC MP BL GC HY PR	ECO504	AL	2	28,00	0,064	174,00
 <p>MESA 80</p>	NC MP BL GC HY PR	ECO510	AL	2	22,00	0,057	164,00

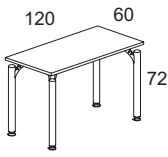
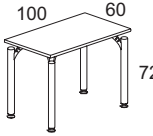
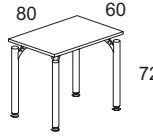
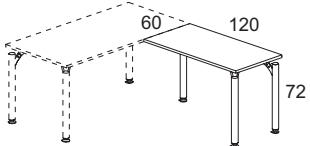
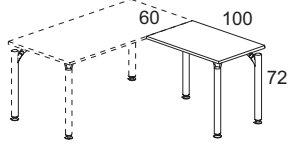
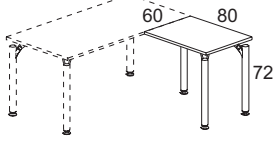
DESCRIPCIÓN / MEDIDAS	ACABADOS GRUPO 1	REF.	ACABADOS GRUPO 2		KG	M ³	€
 <p>MESA AUXILIAR 120</p>	NC MP BL GC HY PR	ECO5081	AL	2	23,30	0,059	167,00
 <p>MESA AUXILIAR 100</p>	NC MP BL GC HY PR	ECO5082	AL	2	21,00	0,055	163,50
 <p>MESA AUXILIAR 80</p>	NC MP BL GC HY PR	ECO5083	AL	2	19,00	0,051	159,50
 <p>ALERON DE MESA 120</p>	NC MP BL GC HY PR	ECO5091	AL	2	18,30	0,049	108,00
 <p>ALERON DE MESA 100</p>	NC MP BL GC HY PR	ECO5092	AL	2	16,00	0,045	104,00
 <p>ALERON DE MESA 80</p>	NC MP BL GC HY PR	ECO5093	AL	2	14,00	0,041	100,50

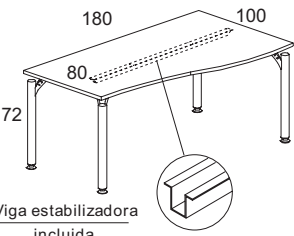
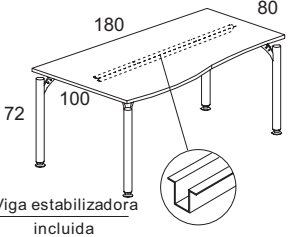
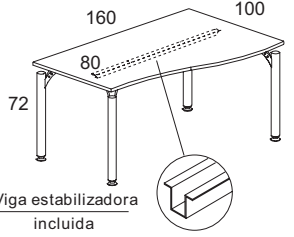
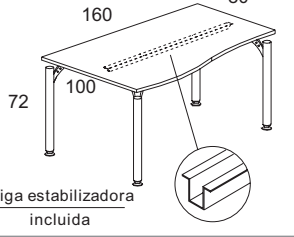
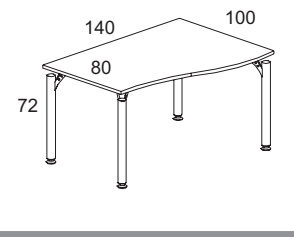
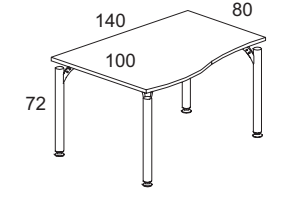

DESCRIPCIÓN / MEDIDAS	ACABADOS GRUPO 1	REF.	ACABADOS GRUPO 2		KG	M ³	€
 <p>MESA OLA 180 D.</p>	NC MP BL GC HY PR	ECO471D	AL	3	39,73	0,094	244,00
 <p>MESA OLA 180 I</p>	NC MP BL GC HY PR	ECO471I	AL	3	39,73	0,094	244,00
 <p>MESA OLA 160 D.</p>	NC MP BL GC HY PR	ECO472D	AL	3	36,63	0,083	233,50
 <p>MESA OLA 160 I</p>	NC MP BL GC HY PR	ECO472I	AL	3	36,63	0,083	233,50
 <p>MESA OLA 140 D.</p>	NC MP BL GC HY PR	ECO473D	AL	2	30,96	0,079	200,00
 <p>MESA OLA 140 I</p>	NC MP BL GC HY PR	ECO473I	AL	2	30,96	0,079	200,00

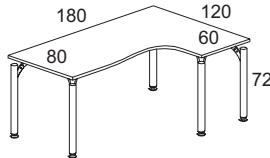
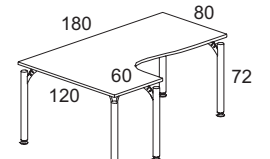
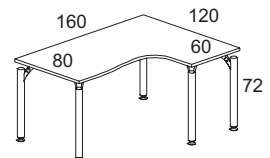
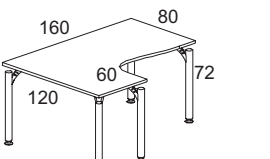
Mobiliario para oficinas y colectividades <> Mamparas, techo y suelo Practicable

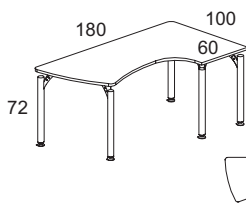
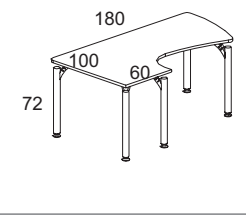
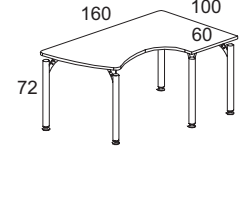
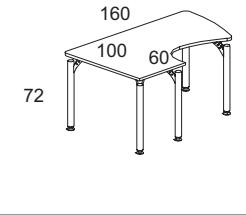
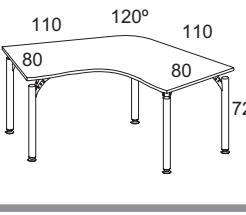
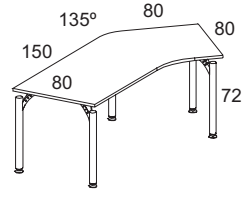
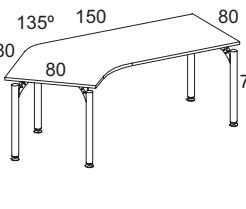
DESCRIPCIÓN / MEDIDAS	ACABADOS GRUPO 1	REF.	ACABADOS GRUPO 2		KG	M ³	€
 <p>MESA 180*120 D.</p>	NC MP BL GC HY PR	ECO411D	AL	2	47,06	0,089	254,50
 <p>MESA 180*120 I.</p>	NC MP BL GC HY PR	ECO411I	AL	2	47,06	0,089	254,50
 <p>MESA 160*120 D.</p>	NC MP BL GC HY PR	ECO412D	AL	2	42,50	0,079	247,00
 <p>MESA 160*120 I.</p>	NC MP BL GC HY PR	ECO412I	AL	2	42,50	0,079	247,00

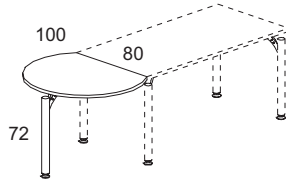
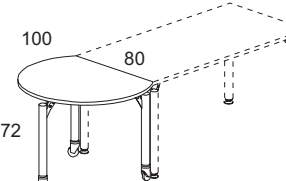
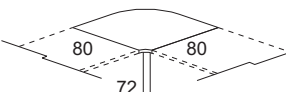
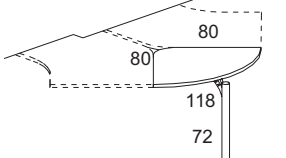
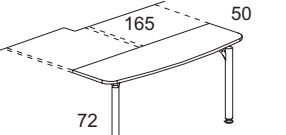
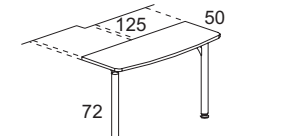
DESCRIPCIÓN / MEDIDAS	ACABADOS GRUPO 1	REF.	ACABADOS GRUPO 2		KG	M ³	€
 <p>MESA 180x100 D</p>	NC MP BL GC HY PR	ECO478D	AL	2	35,93	0,089	238,00
 <p>MESA 180x100 I</p>	NC MP BL GC HY PR	ECO478I	AL	2	35,93	0,089	238,00
 <p>MESA 160x100 D</p>	NC MP BL GC HY PR	ECO479D	AL	2	33,95	0,079	232,50
 <p>MESA 160x100 I</p>	NC MP BL GC HY PR	ECO479I	AL	2	33,95	0,079	232,50
 <p>MESA 120°</p>	NC MP BL GC HY PR	ECO405	AL	2	36,50	0,075	265,50
 <p>MESA 135° D.</p>	NC MP BL GC HY PR	ECO430D	AL	2	39,50	0,081	291,00
 <p>MESA 135° I.</p>	NC MP BL GC HY PR	ECO430I	AL	2	39,50	0,081	291,00

DESCRIPCIÓN / MEDIDAS	ACABADOS GRUPO 1	REF.	ACABADOS GRUPO 2		KG	M ³	€
 <p>MESA "GOTA"</p> <p>Tubo ø60</p>	NC MP BL GC HY PR	ECO422	AL	2	18,50	0,049	103,00
 <p>MESA "GOTA"</p> <p>Tubo ø60</p>	NC MP BL GC HY PR	ECO422R	AL	2	24,30	0,049	203,00
 <p>ANGULO 90° PIE ECO</p> <p>Tubo ø60</p>	NC MP BL GC HY PR AL	ECO452-1	AL	2	14,50	0,053	118,00
 <p>ANGULO UNION MESA 135° PIE ECO</p> <p>Tubo ø60</p>	NC MP BL GC HY PR AL	ECO461-1M	AL	2	14,50	0,053	118,00
 <p>ANGULO TERMINACION PIE ECO</p> <p>Tubo ø60</p>	NC MP BL GC HY PR AL	ECO458-M	AL	2	21,50	0,070	134,00
 <p>ANGULO TERMINACION PIE ECO</p> <p>Tubo ø60</p>	NC MP BL GC HY PR AL	ECO459-M	AL	2	15,00	0,060	125,50

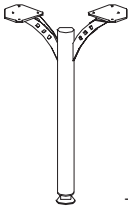
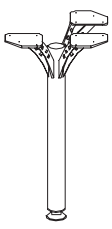
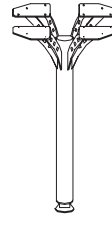
DESCRIPCIÓN / MEDIDAS	ACABADOS GRUPO 1	REF.	ACABADOS GRUPO 2		KG	M ³	€
 <p>Tubo ø60</p> <p>PIE METALICO ECO</p>		TUE011	AL	1	2,50	0,029	33,50
 <p>Tubo ø60</p> <p>PIE METALICO ECO 2 SOPORTES</p>		TUE021	AL	1	3,30	0,045	56,50
 <p>Tubo ø60</p> <p>PIE METALICO ECO 3 SOPORTES</p>		TUE031	AL	1	4,10	0,061	66,00
 <p>Tubo ø60</p> <p>PIE METALICO ECO 4 SOPORTES</p>		TUE041	AL	1	4,90	0,077	75,50

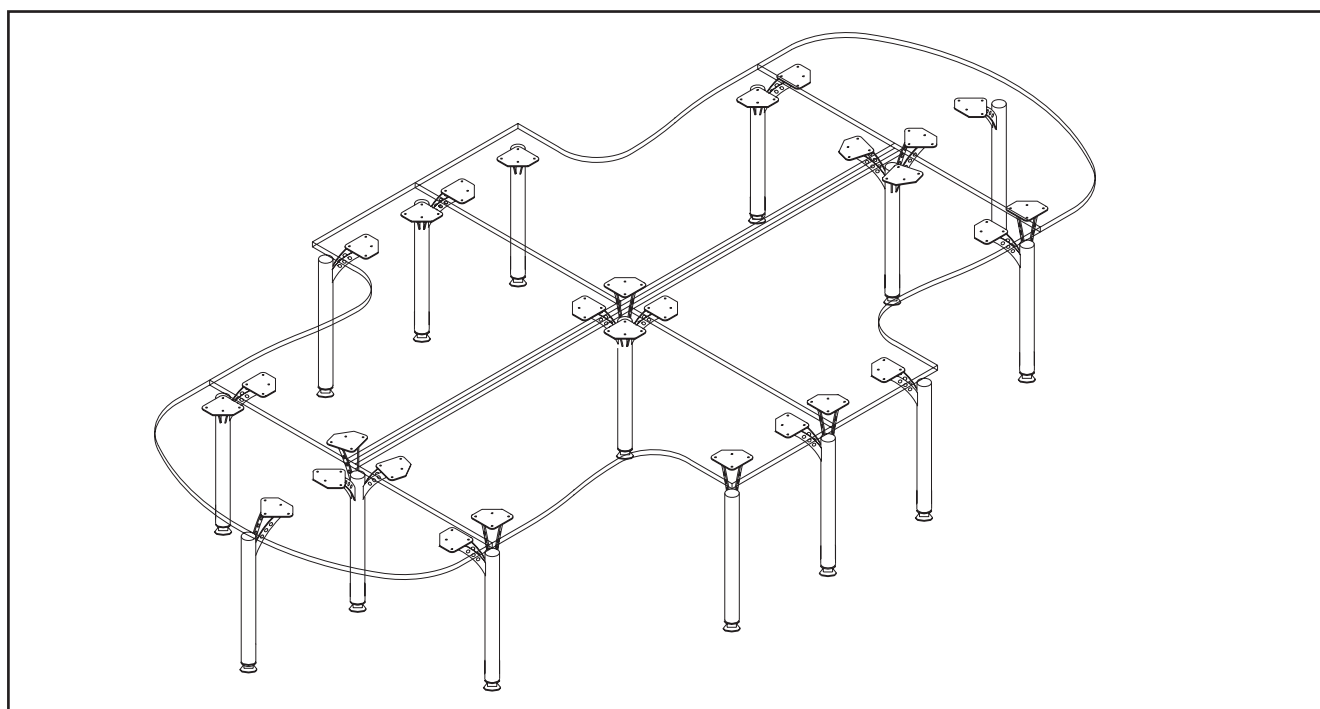

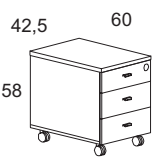
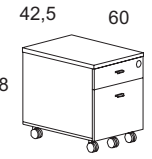
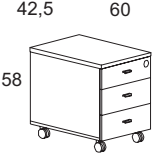
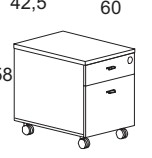
CAJONERAS / MEDIDAS	ACABADOS GRUPO 1	REF.	ACABADOS GRUPO 2		KG	M ³	€
 <p>CAJ.RUEDAS 3CAJONES MADERA</p> <p>(2)</p>	NC MP BL GC HY PR	NL72009		1	26,00	0,161	126,50
 <p>CAJ.RUEDAS 1CAJ.+1 ARCHIVO MADERA</p> <p>5° RUEDA</p> <p>(2)</p>	NC MP BL GC HY PR	NL72010		1	24,10	0,161	121,00
 <p>CAJ.RUEDAS 3CAJ. METALICOS</p> <p>SIST.ANTIVUELCO</p> <p>(2)</p>	NC MP BL GC HY PR	NL72011		1	26,00	0,161	214,50
 <p>CAJ.RUEDAS 1 CAJ.+1 ARCHIVO METALICOS</p> <p>SIST.ANTIVUELCO</p> <p>(2)</p>	NC MP BL GC HY PR	NL72012		1	24,10	0,161	206,00

- (2) -BANDEJA PORTALAPICES NO INCLUIDA
 -CERRADURA INCLUIDA
 -TECHO DE 19 mm. INCLUIDO

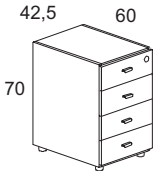
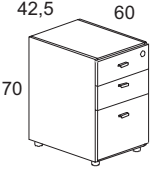
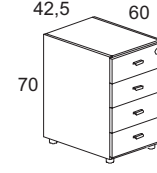
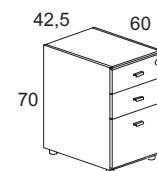
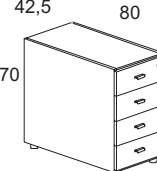
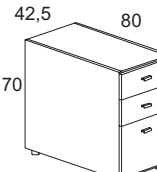

<p>OPCIONAL</p>  <p>BANDEJA PORTALAPICES (PVC PARA CAJONERAS)</p> <p>EXTENSIBLE</p>		BT391		1	1,00	0,076	7,00
--	--	-------	--	---	------	-------	------

DESCRIPCIÓN / MEDIDAS	ACABADOS GRUPO 1	REF.	ACABADOS GRUPO 2		KG	M ³	€
 <p>CAJ. 4C METALICOS</p> <p>SIST.ANTIVUELCO (3)</p>	NC MP BL GC HY PR	NL72013		1	38,00	0,185	253,50
 <p>CAJ. 2C + 1A METALICO</p> <p>SIST.ANTIVUELCO (3)</p>	NC MP BL GC HY PR	NL72014		1	36,60	0,185	241,50
 <p>CAJ. 4C MADERA</p> <p>SIST.ANTIVUELCO (3)</p>	NC MP BL GC HY PR	NL72015		1	30,00	0,185	170,00
 <p>CAJ. 2C + 1A MADERA</p> <p>SIST.ANTIVUELCO (3)</p>	NC MP BL GC HY PR	NL72016		1	28,00	0,185	161,00
 <p>CAJ. 4C METALICO</p> <p>SIST.ANTIVUELCO (3)</p>	NC MP BL GC HY PR	NL72017		1	56,62	0,269	280,00
 <p>CAJ. 2C + 1A METALICO</p> <p>SIST.ANTIVUELCO (3)</p>	NC MP BL GC HY PR	NL72018		1	51,62	0,269	268,00

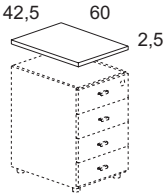
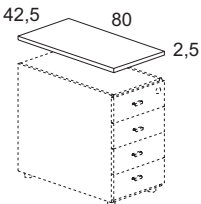
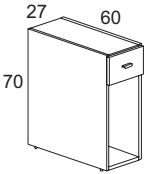
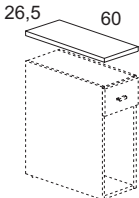
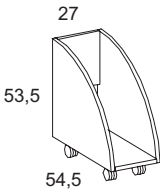
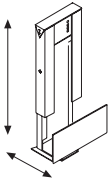
(3) -EN EL PRECIO DE LA CAJONERA NO ESTA INCLUIDO EL TECHO DE 25 mm.
BANDEJA PORTALAPICES NO INCLUIDA

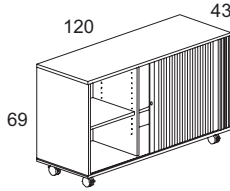
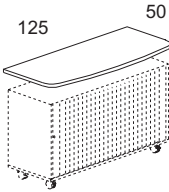
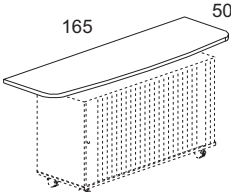
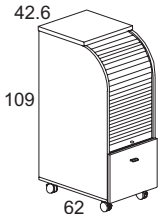
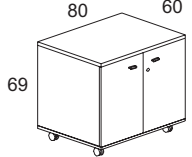
DESCRIPCIÓN / MEDIDAS	ACABADOS GRUPO 1	REF.	ACABADOS GRUPO 2		KG	M ³	€
 <p>TAPA CAJONERA</p>	NC MP BL GC HY PR	NL72019		1	4,70	0,008	26,00
 <p>TAPA CAJONERA</p>	NC MP BL GC HY PR	NL72020		1	5,90	0,009	29,00
 <p>SOPORTE "CPU"</p> <p>(3)</p>	NC MP BL GC HY PR	NL72021		1	10,20	0,127	93,50
 <p>TAPA "CPU"</p>	NC MP BL GC HY PR	NL72022		1	3,00	0,005	22,00
 <p>SOPORTE "CPU"</p>	AL	NL72023		1	7,00	0,07	50,50
 <p>SOPORTE "CPU" METALICO COLGANTE</p> <p>REGULABLE</p>		NL400	AL	1	4,50	0,03	56,50

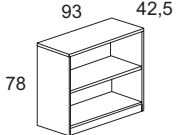
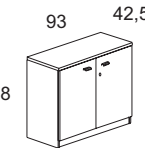
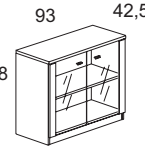
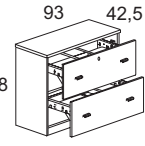
DESCRIPCIÓN / MEDIDAS	ACABADOS GRUPO 1	REF.	ACABADOS GRUPO 2		KG	M ³	€
 <p>ARM. BAJO PERSIANA "RODANTE" "CON CERRADURA"</p>	AL	NL72024		1	40,00	0,362	328,00
 <p>TECHO ARM. BAJO PERSIANA</p>	NC MP BL GC HY PR AL	NL72025		1	10,00	0,031	45,50
 <p>TECHO ARM. BAJO PERSIANA</p>	NC MP BL GC HY PR AL	NL72026		1	16,50	0,041	54,00
 <p>CADY CON ARCHIVADOR "RODANTE" "CON CERRADURA"</p>	AL	NL72027	NC MP BL GC HY PR	1	37,00	0,300	352,50
 <p>ARM. BAJO 80x60 "RODANTE" "CON CERRADURA"</p>	NC MP BL GC HY PR	NLN72028		3	44,00	0,322	278,50

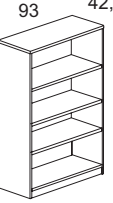
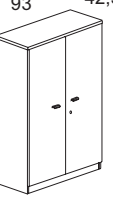
ARMARIO. BAJO / MEDIDAS	ACABADOS GRUPO 1	REF.	ACABADOS GRUPO 2		KG	M ³	€
 <p>(4) (*)</p>	NC MP BL GC HY PR	NLN70019		3	29,40	0,065	88,50
 <p>CON PUERTAS</p> <p>(4) (*)</p>	NC MP BL GC HY PR	NLN70020		4	37,70	0,077	142,50
 <p>PUERTAS CRISTAL PERFIL COLOR</p> <p>CRISTAL MATE BLANCO</p> <p>(4) (*)</p>	NC MP BL GC HY PR	NLN70063		3	45,90	0,075	266,00
 <p>ARCHIVOS</p> <p>CERRADURA CENTRALIZADA SISTEMA ANTIVUELCO SISTEMA ANTIBALANCEO PRE-MONTADO DE FABRICA EXTRACCIÓN TOTAL</p> <p>(4) (*)</p>	NC MP BL GC HY PR	NLN70050		5	48,27	0,092	461,00
ARMARIO. MEDIANO / MEDIDAS	ACABADOS GRUPO 1	REF.	ACABADOS GRUPO 2		KG	M ³	€
 <p>(4) (*)</p>	NC MP BL GC HY PR	NLN70022		4	37,40	0,086	142,50
 <p>CON PUERTAS</p> <p>(4) (*)</p>	NC MP BL GC HY PR	NLN70023		5	53,90	0,111	217,00

(*) ATENCIÓN: ARMARIOS TODO DE COLOR

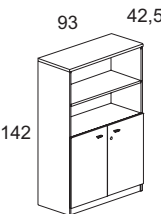
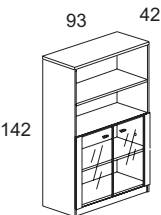
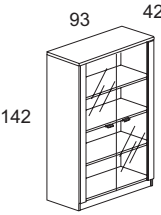
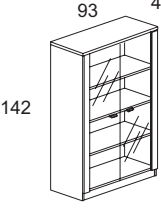
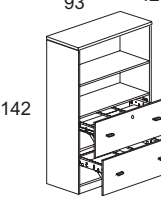
DESCRIPCIÓN / MEDIDAS	ACABADOS GRUPO 1	REF.	ACABADOS GRUPO 2		KG	M ³	€
 <p>93 42,5 142</p> <p>PUERTAS BAJAS</p> <p>(4) (*)</p>	NC MP BL GC HY PR	NLN70064		5	45,70	0,098	196,00
 <p>93 42,5 142</p> <p>PUERTAS BAJAS CRISTAL PERFIL COLOR</p> <p>CRISTAL MATE BLANCO SIN CERRADURA</p> <p>(4) (*)</p>	NC MP BL GC HY PR	NLN70065		5	53,90	0,096	319,50
 <p>93 42,5 142</p> <p>PUERTAS DE CRISTAL</p> <p>CRISTAL PARSOL BRONCE SIN CERRADURA</p> <p>(4) (*)</p>	NC MP BL GC HY PR	NLN70025		5	63,40	0,119	294,00
 <p>93 42,5 142</p> <p>PUERTAS DE CRISTAL</p> <p>CRISTAL MATE BLANCO SIN CERRADURA</p> <p>(4) (*)</p>	NC MP BL GC HY PR	NLN70066		5	63,40	0,119	385,00
 <p>93 42,5 142</p> <p>ARCHIVOS</p> <p>CERRADURA CENTRALIZADA SISTEMA ANTIVUELCO SISTEMA ANTIBALANCEO PRE-MONTADO EN FABRICA EXTRACCIÓN TOTAL</p> <p>(4) (*)</p>	NC MP BL GC HY PR	NLN70051		6	56,27	0,113	515,00

(4)

INCLUYE:

- Cerradura de sobreponer.
- Techo 25 mm. estructural incluido en precio
- Armarios todo color
- Estantes de 25mm. incluidos en el precio.
- Doble zócalo

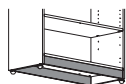

(*) ATENCIÓN: ARMARIOS TODO DE COLOR

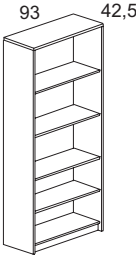
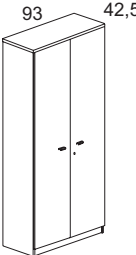
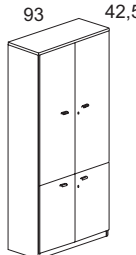
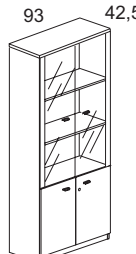
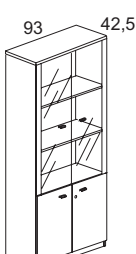
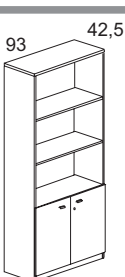
DESCRIPCIÓN / MEDIDAS	ACABADOS GRUPO 1	REF.	ACABADOS GRUPO 2		KG	M ³	€
 <p>(4) (*)</p>	NC MP BL GC HY PR	NLN70027		4	64,40	0,111	189,50
 <p>PUERTAS</p> <p>(4) (*)</p>	NC MP BL GC HY PR	NLN70028		5	87,40	0,151	282,00
 <p>PUERTAS MEDIANAS Y BAJAS</p> <p>(4) (*)</p>	NC MP BL GC HY PR	NLN70041		6	89,20	0,148	318,50
 <p>PUERTAS CRISTAL Y BAJAS</p> <p>CRISTAL PARSOL BRONCE</p> <p>(4) (*)</p>	NC MP BL GC HY PR	NLN70030		6	98,70	0,156	395,00
 <p>PUERTAS CRISTAL Y BAJAS</p> <p>CRISTAL MATE BLANCO</p> <p>(4) (*)</p>	NC MP BL GC HY PR	NLN70067		6	98,70	0,156	486,00
 <p>PUERTAS BAJAS</p> <p>(4) (*)</p>	NC MP BL GC HY PR	NLN70032		5	72,70	0,123	243,00

(*) ATENCIÓN: ARMARIOS TODO DE COLOR

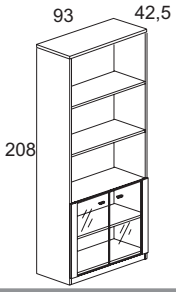
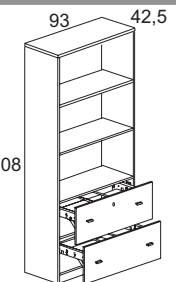
DESCRIPCIÓN / MEDIDAS	ACABADOS GRUPO 1	REF.	ACABADOS GRUPO 2		KG	M ³	€
 <p>PUERTAS BAJAS CRISTAL</p> <p>CRISTAL MATE BLANCO SIN CERRADURA (4) (*)</p>	NC MP BL GC HY PR	NLN70068		5	80,90	0,121	367,50
 <p>ARCHIVOS</p> <p>CERRADURA CENTRALIZADA SISTEMA ANTIVUELCO SISTEMA ANTIBALANCEO PRE-MONTADO EN FABRICA ESTRACCIÓN TOTAL (4) (*)</p>	NC MP BL GC HY PR	NLN70052		6	83,27	0,138	562,00

(*) ATENCIÓN: ARMARIOS TODO DE COLOR

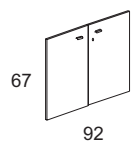

 <p>JUEGO PUERTAS BAJAS</p> <p>(4)</p>	NC MP BL GC HY PR	NLN70034		1	8,30	0,012	53,50
 <p>JUEGO PUERTAS MEDIANAS</p> <p>(4)</p>	NC MP BL GC HY PR	NLN70035		1	16,50	0,025	75,00
 <p>JUEGO PUERTAS ALTAS</p> <p>(4)</p>	NC MP BL GC HY PR	NLN70036		1	23,00	0,040	92,00

NOTA:

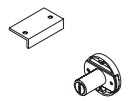

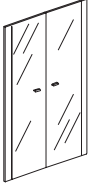
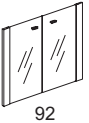
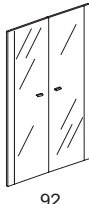
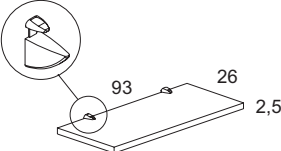
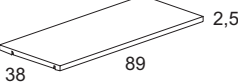
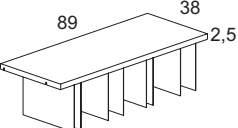

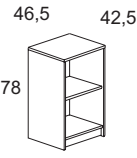
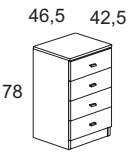
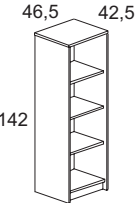
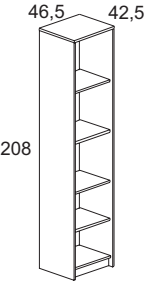
TODAS LAS PUERTAS LLEVAN CERRADURA DE SOBREPONER SI NO DESEAN CERRADURA INDIQUEN LA SIGUIENTE REFERENCIA Y DESCONTAR EL VALOR AL ARMARIO.



 <p>CERRADURA DE SOBREPONER</p>		3070950		1	0,001	0,001	11,00
--	--	---------	--	---	-------	-------	-------

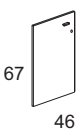
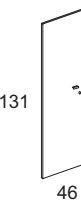
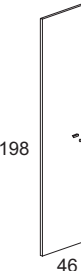

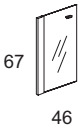

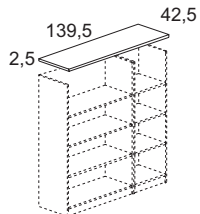
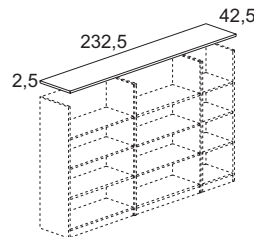
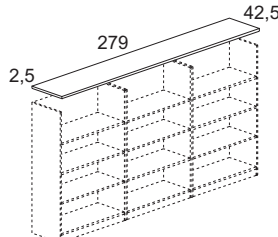

DESCRIPCIÓN / MEDIDAS	ACABADOS GRUPO 1	REF.	ACABADOS GRUPO 2		KG	M ³	€
 <p>JGO.PUERTAS MEDIANAS CRISTAL</p> <p>CRISTAL PARSOL BRONCE SIN CERRADURA</p>	NC MP BL GC HY PR	NLN70037		1	26,00	0,033	152,00
 <p>JGO.PUERTAS BAJAS CRISTAL</p> <p>CRISTAL MATE BLANCO SIN CERRADURA</p>	NC MP BL GC HY PR	NLN70069		1	16,50	0,010	177,00
 <p>JGO.PUERTAS MEDIANAS CRISTAL</p> <p>CRISTAL MATE BLANCO SIN CERRADURA</p>	NC MP BL GC HY PR	NLN70070		1	26,00	0,033	242,00
 <p>ESTANTE PARED</p> <p>INCLUYE FIJACIONES A PARED</p>	NC MP BL GC HY PR	E235		2	4,20	0,008	43,50
 <p>ESTANTE ARM. 2 PUERTAS</p>	NC MP BL GC HY PR	E240		1	5,40	0,008	15,50
 <p>ESTANTE METÁLICO ARM. 2 PUERTAS</p> <p>APTO PARA CARPETAS COLGANTES</p>	AL	BMM 890		1	3,40	0,008	28,00

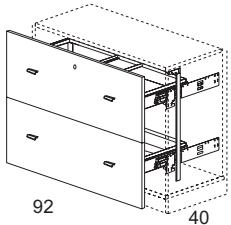
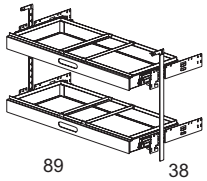
ARMARIOS ESTRECHOS / MEDIDAS	ACABADOS GRUPO 1	REF.	ACABADOS GRUPO 2		KG	M ³	€
 <p>ESTANTE DE 25 mm. (4) (*)</p>	NC MP BL GC HY PR	NLN70053		2	18,80	0,039	65,50
 <p>4 CAJONES SIN CERRADURA (4) (*)</p>	NC MP BL GC HY PR	NLN70033		1	22,50	0,154	153,00
 <p>ESTANTES DE 25 mm. (4) (*)</p>	NC MP BL GC HY PR	NLN70054		2	32,80	0,066	99,00
 <p>ESTANTES DE 25 mm. (4) (*)</p>	NC MP BL GC HY PR	NLN70055		3	43,80	0,097	130,00
 <p>ESTANTE ARM. 1 PUERTA</p>	NC MP BL GC HY PR	E250		1	2,10	0,003	9,50

(*) ATENCIÓN: ARMARIOS TODO DE COLOR

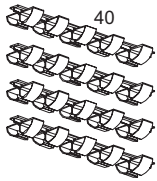
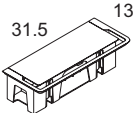
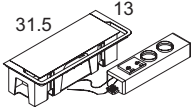
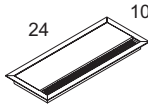
DESCRIPCIÓN / MEDIDAS	ACABADOS GRUPO 1	REF.	ACABADOS GRUPO 2		KG	M ³	€
 <p>PUERTA BAJA CON CERRADURA</p>	NC MP BL GC HY PR	NLN70056		1	4,30	0,007	44,00
 <p>PUERTA MEDIANA CON CERRADURA</p>	NC MP BL GC HY PR	NLN70057		1	8,70	0,012	53,50
 <p>PUERTA ALTA CON CERRADURA</p>	NC MP BL GC HY PR	NLN70058		1	12,30	0,017	72,00
 <p>PUERTA MEDIANA CRISTAL CRISTAL PARSOL BRONCE SIN CERRADURA</p>	NC MP BL GC HY PR	NLN70059		1	12,35	0,014	80,00
 <p>PUERTA BAJA CRISTAL CRISTAL MATE BLANCO SIN CERRADURA</p>	NC MP BL GC HY PR	NLN70071		1	8,20	0,006	91,50
 <p>PUERTA MEDIANA CRISTAL CRISTAL MATE BLANCO SIN CERRADURA</p>	NC MP BL GC HY PR	NLN70072		1	12,35	0,014	127,00

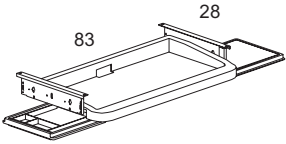
DESCRIPCIÓN / MEDIDAS	ACABADOS GRUPO 1	REF.	ACABADOS GRUPO 2		KG	M ³	€
 <p>TECHO ARM. 3 PUERTAS</p>	NC MP BL GC HY PR	NLN70046		1	9,80	0,016	0,00
 <p>TECHO ARM. 4 PUERTAS</p>	NC MP BL GC HY PR	NLN70047		1	13,80	0,022	0,00
 <p>TECHO ARM. 5 PUERTAS</p>	NC MP BL GC HY PR	NLN70048		1	17,00	0,028	0,00
 <p>TECHO ARM. 6 PUERTAS</p>	NC MP BL GC HY PR	NLN70049		1	20,40	0,033	0,00
ACCESORIOS / MEDIDAS	ACABADOS GRUPO 1	REF.	ACABADOS GRUPO 2		KG	M ³	€
 <p>KIT ARCHIVOS CERRADURA CENTRALIZADA SISTEMA ANTIVUELCO SISTEMA ANTIBALANCEO PRE-MONTADO EN FABRICA EXTRACCIÓN TOTAL</p>	NC MP BL GC HY PR	149OP		2	18,87	0,027	372,50
 <p>BASTIDOR KIT ARCH. SISTEMA ANTIVUELCO SISTEMA ANTIBALANCEO PRE-MONTADO EN FABRICA EXTRACCIÓN TOTAL</p>		139		1	10,70	0,015	289,00

DESCRIPCIÓN / MEDIDAS	ACABADOS GRUPO 1	REF.	ACABADOS GRUPO 2		KG	M ³	€
 <p>VERTEBRA</p>		PA10		1	1,00	0,002	51,50
 <p>PASACABLE HORIZONTAL</p> <p>4 Tiras de 40 cm.+ 30 Soportes</p>		PA13		1	0,5	0,001	25,00
 <p>BASKET (POLIAMIDA)</p>		PAS315	BL AL	1	0,40	0,006	43,00
 <p>BASKET+ELECTRIFICACION (POLIAMIDA)</p> <p>2 Shukos+ 2 RJ45</p>		PAS316	BL AL	1	1,10	0,006	202,00
 <p>PASACABLE SOBREMESA (ALUMINIO)</p>		PAS240	AL	1	0,25	0,001	44,00
 <p>PASACABLE SOBREMESA (ALUMINIO)</p>		PAS100	AL	1	0,15	0,001	29,00
 <p>BANDEJA TECLADO METÁLICA "RATON"</p>		393		1	5,10	0,029	109,50
 <p>PASACABLES 80 m/m.</p>		PAS80		1	0,030	0,0001	5,50
 <p>KIT BROCA + CORONA 80 m/m.</p>		BRO80		1	4,80	0,009	100,00

CARACTERÍSTICAS GENERALES

Serie Eco

MESAS

Las encimeras, están fabricadas por un panel de partículas aglomeradas de 25 mm. y revestido por ambos lados con papel decorativo impregnado en resinas melamínicas. Cantos de PVC 2 mm. de espesor - sus aristas redondeadas con radio 2 mm.

ESTRUCTURA ECO

Son pies de acero tubular de gran resistencia, con regulación de 13cm. de altura y terminados en anclaje superior a la encimera.

PANEL DIVISOR

Panel divisor de 19 mm. de espesor -, del mismo diseño que los sobes. Cantos de PVC 1 mm. de espesor, sus aristas redondeadas con radio 1 mm.

CAJONERAS

Se fabrican dos tipos de cajoneras: con cajones de madera y con cajones metálicos. Los cuerpos de las cajoneras son de tablero de partículas aglomerado de 19 mm. de espesor, revestidos por ambos lados con papel decorativo impregnado con resinas melamínicas. Para los dos tipos de cajones se utilizan guías metálicas provistas de rodillos recubiertos con material plástico para amortiguar ruidos. Las cerraduras poseen un sistema central de cierre para todos los cajones de madera y sistema de cierre antivuelco para todos los cajones metálicos. Las llaves se suministran con funda bisagra para que no se rompan.

Las cajoneras pueden ser de ruedas o de altura mesa.

ARMARIOS

El programa de armarios de nuestra serie se compone de una gama que permite la elección más idónea a cada exigencia de archivo. La modulación se realiza en tres alturas: 75-139-206 cm y en dos anchuras: 46,5 – 93 cm, mientras que la profundidad es de 43 cm., medido a la altura del sobre de acabado.

Dispone de nivelador en sus bases.

La estructura de los armarios y los estantes se realizan mediante paneles de partículas aglomeradas de madera, en costados esp. 19 mm y en estantes esp. 25 mm, revestidas ambas caras con papel decorativo impregnado en resinas melamínicas, acabados de la serie. Existe la posibilidad de colocar estantes metálicos.

Los armarios pueden llevar archivadores. El frente del archivador es tablero de aglomerado de 19 mm de espesor revestido por ambos lados de papel decorativo con los colores de la serie. El Kit de archivo lleva un sistema antivuelco y antibalanceo. Este sistema sale pre-montado de fábrica.

PUERTAS EN MADERA

Las puertas con paneles aglomerados espesor 19 mm con revestimiento melamínico acabados en los colores de la serie. Las bisagras de unión a la estructura son metálicas con tratamiento anti-corrosivo, de fácil montaje y regulación, con apertura 105°. Las puertas llevan cerradura.

PUERTAS DE CRISTAL

Puertas medianas en cristal bronce esp. 5 mm, y puertas bajas y medianas en cristal mate blanco espesor 5 mm. con moldura de color de 7 cm. en el lado de la bisagra. Las puertas de cristal nunca llevan cerraduras.

ELECTRIFICACIÓN

La electrificación es una característica opcional y se aplica al sobre de trabajo. Se trata de un sistema disponible en kit que permite subir los cables eléctricos a través de una elegante vértebra haciéndolos salir por el sobre a través de una pieza pasacables realizada en material plástico.

ACABADOS

NC: NOGAL CLARO

MP: MAPLE

BL: BLANCO

GC: GRIS CLARO

HY: HAYA

PR: PERAL

PEDIDOS

Al cursar los pedidos especificar la referencia y el acabado.

DESCRIPCIONES TÉCNICAS

Serie Eco

Nuestros muebles gozan del sello de calidad otorgado por A.I.D.I.M.A.- "Calidad Controlada", tanto por el sistema de fabricación del mueble, como de sus materias primas.

CARACTERÍSTICAS FÍSICO-MECÁNICAS DEL TABLERO DE PARTÍCULAS DE 25 mm DE ESPESOR

ENSAYOS REALIZADOS	MET. ENSAYO	RESULTADO
Peso Específico (kg/m ³)	EN 323	659
Contenido en Humedad (%)	EN 322	8,2
Resistencia Flexión (N/mm ²)	EN 310	Direc.//: 19,1 Direc.⊥: 15,9
Módulo de elasticidad (N/mm ²)	EN 310	Direc.//: 3.180 Direc.⊥: 2.790
Tracción perpendicular (N/mm ²)	EN 319	0,59
Tracción superficial (N/mm ²)	EN 311	1,83
Absorción superficial (mm) 1 gota de tolueno	EN 382	189
Absorción de agua e hinchazón en grosor (2 horas)	EN 317	50
Absorción mas (%)		6,2
Hinchazón espesor (%)		
Emisión de formaldehído Mg HCOH/h.M ²	EN 717	8,1

CARACTERÍSTICAS FÍSICO-MECÁNICAS DE RECUBRIMIENTO MELAMÍNICO

ENSAYOS REALIZADOS	MET. ENSAYO	RESULTADO
Brillo especular (%)	UNE 11 019/1	2,0 8,9 9,4
Color	I	
Luminosidad (l)	ISO 7724/2	57,5 + 16,2 + 23,3
Calidad de las superficies		
Resistencia al manchado	DIN 68 861 EN 483/2 (valoración)	1 A productos de limpieza 5
Resistencia a la abrasión	DIN 68 861 EN 483/2 (nº ciclos)	2 D 100
Resistencia al rayado	DIN 68 861	4 A
Resistencia a las quemaduras por cigarrillo	DIN 68 861	6 D
Resistencia al calor seco	DIN 68 861 EN 483/2 (valoración)	7 A 5
Resistencia al calor húmedo	DIN 68 861	8 A
Resistencia al impacto	EN 483/2	Altura (cm): 110 Huella (mm): 10 Sin aparición en grieta